

# Contents

<b>Welcome.....</b>	<b>9</b>
<b>Using Your VAIO Computer .....</b>	<b>11</b>
Using the Keyboard.....	12
Functions of the keyboard keys .....	12
Indicators .....	14
Indicator lights .....	14
Combinations and functions with the Windows key .....	15
Combinations and functions with the Fn key .....	16
Using the Touchpad .....	18
VAIO Action Setup.....	20
Using the Center Jog Dial Control .....	21
Using the center Jog Dial control .....	21
Launcher mode .....	22
Using Guide Mode.....	23
Using the center Jog Dial control with Sony software .....	23
Using the center Jog Dial control with other software .....	24
Using a PC Card.....	25
Notes on using PC Cards .....	27

Using Memory Stick Media..... 28

- Types of Memory Stick media..... 28
- Inserting Memory Stick media..... 28
- Viewing the contents of a Memory Stick media..... 29
- Removing Memory Stick media ..... 29
- Write-protecting a Memory Stick media ..... 30
- Formatting a Memory Stick media ..... 30
- Notes on Memory Stick media..... 31

Using Power Saving Modes..... 33

- Normal mode..... 33
- Standby mode..... 33
- Hibernate mode..... 33
- Notes on power saving modes ..... 34

Connecting a Telephone Line ..... 35

Connecting to a LAN ..... 36

- Setting up your Ethernet connection..... 36

Connecting to a Wireless LAN..... 38

- Turning On Wireless LAN..... 38
- The Wireless LAN Access Point ..... 38
- Communication with an Access Point (infrastructure)..... 39
- Communicating without an Access Point (peer-to-peer).. 40
- Turning Off Wireless LAN..... 41
- Notes on using Wireless LAN ..... 41

**Connecting Peripheral Devices ..... 43**

Connecting the Docking Station ..... 44

- Connecting the computer to the docking station..... 46
- Disconnecting the computer from the docking station ..... 48
- Disconnecting the docking station when the computer is on  
49

Using the Floppy Disk Drive ..... 52

---

Using an Optical Disc Drive .....	54
Playing a DVD .....	55
Playing an audio CD .....	56
Notes on CD and DVD discs .....	57
Connecting an i.LINK Optical Disc Drive .....	58
Connecting an i.LINK optical disc drive .....	58
Notes on using i.LINK optical disc drives .....	60
Connecting a Parallel Port Printer .....	61
Connecting a USB Printer .....	62
Connecting an External Display .....	63
Connecting a USB Device .....	68
Connecting an i.LINK Device .....	70
Notes on i.LINK devices .....	71
Connecting VAIO Computers .....	73
If your computer is connected to the docking station .....	74
Connecting External Speakers .....	76
Connecting an External Microphone .....	77
Expanding Your Computer Capabilities .....	78
Personal Digital Assistant .....	78
Wireless LAN Access Point .....	78

## ***Customizing Your VAIO Computer .....*** 81

Displaying the Sony Notebook Setup Screen .....	82
Sony Notebook Setup tabs .....	83
Controlling Power Management .....	84
Viewing the Power Management status icons .....	84
Power Management profiles .....	85
Power Management commands .....	87
Conserving battery power .....	88

Displaying Battery Information .....	89
Battery icon descriptions.....	89
Displaying detailed battery information .....	90
Selecting the Display Mode .....	92
To select the display mode.....	92
To change the window design of Sony software .....	92

**Adding Memory ..... 95**

Precautions and Procedures .....	96
Typical expansion memory configuration .....	96
Removing a Memory Module.....	98
Installing a Memory Module .....	99
Viewing Memory .....	102

**About the Software on Your Computer. 103**

Overview of the Software on Your Computer .....	104
Software Support Information .....	110
Sony Service Center.....	113

**VAIO AV Applications..... 115**

Overview of Preinstalled Software .....	116
DigitalPrint Software .....	119
Using PhotoCapture .....	119
Using PhotoCollection .....	122
Using PhotoDecor.....	124
Using PhotoAlbum.....	125
Using LabelMaker.....	127
DVgate Software.....	129

---

MovieShaker Software .....	131
Creating movies with MovieShaker software.....	132
Using the ImageStation online service with MovieShaker software.....	136
Smart Capture Software .....	139
Using Still Mode.....	140
Using Net Movie Mode .....	143
Using the ImageStation online service with Smart Capture software.....	146
SonicStage Software .....	149
Electronic Music Distribution (EMD) Services.....	149
Starting SonicStage Software .....	149
Recording from a CD.....	151
Transferring songs (Check-In/Check-Out) .....	153
Additional features.....	155
SonicStage Premium Software.....	157
Overview of SonicStage Premium Software .....	157
Using SonicStage Premium Software.....	159
Using Playback and Recording Features .....	165
Using the Visualizer, Equalizer, and Sound Effects.....	171
Using the FM Tuner.....	173
Using the Timer Functions .....	175
Additional Information .....	177

***Additional Software Information..... 179***

***Legal Information .....*** 181

***Using the Recovery CDs..... 183***

Application and System Recovery CDs.....	184
--	-----

Using Your Recovery CDs ..... 185  
    Using the Application Recovery CD(s) ..... 185  
    Using the System Recovery CD(s) ..... 187

**Troubleshooting..... 191**

Troubleshooting Your Computer ..... 192  
    My computer does not start..... 192  
    My computer starts but a BIOS error appears..... 192  
    My computer starts, but the message “Operating system not found” appears, and Windows does not start..... 193  
    My computer stops responding or does not shut down... 194  
    My computer is unstable. .... 195  
    The sound of my computer’s fan is too loud. .... 195  
    Why does the System Properties dialog box display a slower CPU speed than advertised?..... 195  
Troubleshooting the Docking Station ..... 196  
    I cannot operate the optical drive in the docking station, when the docking station is connected to the computer.. 196  
    I cannot operate the optical drive in the docking station, when the docking station is connected to the computer and the computer is connected to another computer via an i.LINK connection. .... 196  
    An error message appears while disconnecting the docking station, even after following the correct procedure for disconnecting the docking station..... 197  
    I cannot remove the disc. .... 197  
    The disc tray does not eject even after I press the Eject button..... 197  
Troubleshooting the LCD Screen ..... 198  
    My LCD screen is blank. .... 198  
    My LCD screen continues to show the previous screen. 198  
    The image on my connected external display is not centered

---

or sized properly. ....	198
I want to change the video resolution of my display. ....	198
<b>Troubleshooting the Mouse and Touchpad</b> .....	<b>199</b>
My mouse does not work. ....	199
My touchpad does not work properly. ....	199
The pointer does not move when I use the Touchpad or Mouse. ....	200
<b>Troubleshooting Drives, PC Cards, and Peripheral De- vices</b> .....	<b>201</b>
My floppy disk drive cannot write to a floppy disk. ....	201
My optical drive is not playing my CD or DVD properly. ....	201
My optical drive tray does not open. ....	202
I cannot use Digital Video (DV) devices. The message “DV equipment seems to be disconnected or turned off” appears. 202	202
My PC Card does not work. ....	202
<b>Troubleshooting the Software</b> .....	<b>203</b>
My software program stops responding or crashes. ....	203
When I click an application icon, the message “You must in- sert the application CD into your optical drive” appears, and the software does not start. ....	203
The application cannot find a file while a PC Card is insert- ed. ....	203
What software do I use for CD-R/CD-RW software func- tions? .....	203
<b>Troubleshooting i.LINK Devices</b> .....	<b>204</b>
I cannot establish a connection between two VAIO comput- ers when using an i.LINK cable. ....	204
<b>Troubleshooting the Modem</b> .....	<b>205</b>
My modem does not work. ....	205
My modem connection is slow. ....	205

Troubleshooting Audio .....	206
My speakers have no sound. ....	206
My microphone does not work. ....	207
Troubleshooting Wireless LAN functions .....	208
I cannot use the Wireless LAN functionality .....	208
I cannot set up a Wireless LAN. ....	208
The computer cannot connect to a Wireless LAN Access Point. ....	209
I cannot access the Internet. ....	209
The data transfer speed is slow. ....	210
The communication speed is interrupted or slowed down when MPEG2 data is transferred. ....	210
The IBSS Ad-hoc mode channel is different from the one I specified. ....	210
The settings cannot be saved in “Edit Configuration,” even when I enter the encryption key with “Use hexadecimal.” ... 210	
The computer connects automatically to a Wireless LAN Access Point. ....	210
Troubleshooting the Printer .....	211
I cannot print. ....	211
<b>Getting Help.....</b>	<b>213</b>
Support Options .....	213
<b>Index.....</b>	<b>215</b>



# Welcome

*Congratulations on your purchase of this Sony VAIO® computer, and welcome to the online VAIO® Computer User Guide.*

*This user guide provides detailed information on all aspects of using your new VAIO computer, from keyboard functions to preinstalled software applications.*

*In the left navigation window, click the topics you want to learn more about, and that information will be displayed in this main window.*



Click here to find the latest updates and supplemental information about your computer.



# *Using Your VAIO Computer*

*This section describes the following aspects of your new computer:*

- ❑ Using the Keyboard
- ❑ Using the Touchpad
- ❑ VAIO Action Setup
- ❑ Using the Center Jog Dial Control
- ❑ Using a PC Card
- ❑ Using Memory Stick Media
- ❑ Using Power Saving Modes
- ❑ Connecting a Telephone Line
- ❑ Connecting to a LAN
- ❑ Connecting to a Wireless LAN

## Using the Keyboard

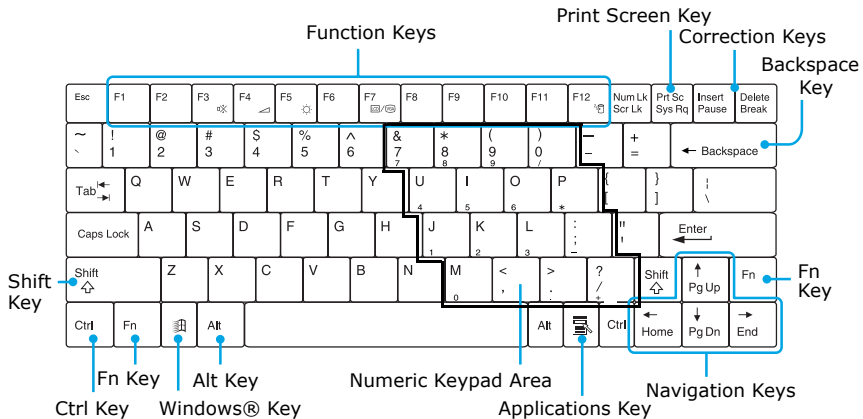

Your keyboard is very similar to that of a typewriter, but the keyboard has additional keys that perform specific computer-related tasks.

### Keyboard







### Functions of the keyboard keys

Key	Description
Numeric keypad area	Contains the keys found on a typical calculator. Use the numeric keypad area to type numbers or to perform mathematical calculations such as addition and subtraction. Note: You must press the Num Lock key to activate the numeric keypad. (When you do so, the Num Lock indicator will be on.) Press the Num Lock key again to deactivate it.
Navigation keys	The Left/Right/Up/Down arrows move the cursor on the screen and also function as the Home, End, Page Up, and Page Down keys, respectively.
Correction keys	The Insert, Backspace, and Delete keys enable you to make corrections in your documents.



<b>Key</b>	<b>Description</b>
Function keys	The 12 function keys along the top of the keyboard are used to perform designated tasks. For example, in many applications, F1 is the Help key. The task associated with each function key may vary from one application to the next.
Escape key	The Esc (Escape) key is used to cancel commands.
Print Screen key	The Print Screen key takes an electronic snapshot of the screen and places it in the Windows® Clipboard. You can then paste the screen shot into a document and print it.
Operator keys	Several keys are always used with at least one other key: Ctrl, Alt, and Shift. When held down with another key, the Ctrl (Control) and Alt (Alternate) keys offer another way to give commands. For example, in many applications, instead of choosing the Save command from a menu, you can hold down Ctrl and press S (referred to as Ctrl+S). The Shift key operates the same way as on a typewriter; it is used to produce capital letters or special symbols such as @ and \$.
Windows key 	The key with the Windows® logo displays the Windows Start menu; it is the equivalent of clicking the Start button on the task bar. See “Combinations and functions with the Windows key” for more information.
Fn key	The Fn key is used in combination with other keys to issue commands. See “Combinations and functions with the Fn key” for more information.
Applications key 	The Applications key displays a shortcut menu of context-sensitive choices. Pressing this key is the equivalent of clicking the right mouse button.

## Indicators







<b>Indicator</b>	<b>Function</b>
Power 	Light is green when the computer is powered on, flashes amber when the computer is in Standby mode, and turns off when the computer is in Hibernate mode or is powered off.
Battery 	Indicates the status of the battery, which is attached at the rear of the computer.
Memory Stick 	Indicates the Memory Stick® slot is in use.
Docking Station 	Indicates the docking station is in use.

## Indicator lights

<b>Light</b>	<b>On</b>	<b>Off</b>
Hard disk 	Data is being read from or written to the hard drive. Do not enter Standby mode or turn off the computer when this indicator light is on.	The hard drive is not being accessed.

<b>Light</b>	<b>On</b>	<b>Off</b>
Num Lock 	The number keys in the numeric keypad are active.	The character keys in the keypad area are active.
Caps Lock 	Letters appear in uppercase as you type. The Shift key lowers the case of typed letters when Caps Lock is on.	Letters appear in lower case as you type (unless you hold down the Shift key).
Scroll Lock 	The screen scrolls differently. (Exactly how it scrolls depends on the specific application. It has no effect in many applications.)	Information moves across the display normally.

### **Combinations and functions with the Windows key**

<b>Combination</b>	<b>Function</b>
 + F1	Displays Windows® Help.
 + Tab	Switches the selected button on the taskbar.
 + E	Displays Windows Explorer.
 + F	Displays the Search window to find a file or folder. This is the equivalent of selecting Search from the Start menu.
 + Ctrl + F	Displays the Search Results: Computers window where you can locate other computers. This is the equivalent of selecting Search and then Computers from the Start menu.
 + M	Minimizes all displayed windows.

---

**Combination    Function**

---

Shift +  + M Returns all minimized windows to their previous size.

 + R Displays the Run window. This is the equivalent of selecting Run from the Start menu.

Fn +  + Insert Displays the System Properties window. This is the equivalent of selecting Control Panel and then System from the Start menu.

---





**Combinations and functions with the Fn key**





---



**Combination/  
Feature                      Functions**

---

Fn+  (F3) Toggles the built-in speaker off and on.  
Speaker switch

Fn+  (F4) Adjusts the built-in speaker volume.  
Speaker volume    To increase volume, press Fn+F4, then  or .  
To decrease volume, press Fn+F4, then  or .

Fn+  (F5) Adjusts brightness of the LCD.  
Brightness control    To increase light intensity, press Fn+F5, then  or .  
To decrease light intensity, press Fn+F5, then  or .

Fn+  /  (F7) Toggles through the LCD and external display.  
Switch to the external display

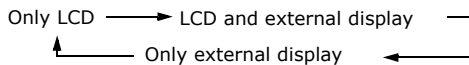



**Combination/  
Feature****Functions**

Fn+  (F12)  
Hibernate

Provides for the lowest level of power consumption. When you execute this command, the state of the system and state of the peripheral devices are written to the hard disk and the system power is turned off. To return the system to the original state, use the power switch to turn on power.

Fn + Esc  
Standby

Puts the system into Standby mode, a power management state. To return the system to the active state, press any key or press the power button on your computer.

Fn +F  
Display control

Minimizes or maximizes the display window. If the default display resolution is reduced, this function maximizes the display resolution to fit the screen size. Maximizing the display window allows you to view the display at a greater resolution.



You can also carry out these functions using the center Jog Dial™ control. Some functions are not available until Windows® launches.

## Using the Touchpad

The keyboard contains a pointing device called a touchpad. You can point to, select, drag, and scroll objects on the screen using the built-in touchpad.

### Touchpad

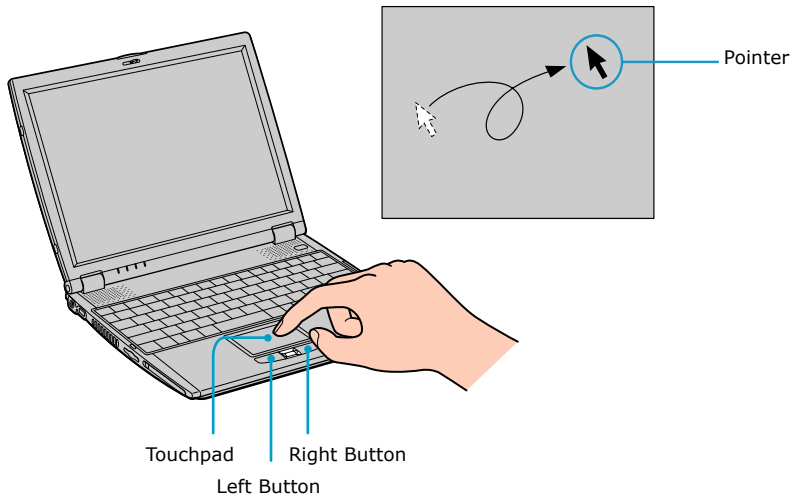

<b>Actions</b>	<b>Descriptions</b>
Point	Slide one finger on the touchpad to place the pointer on an item or object.
Click	Press the left button once.
Double-click	Press the left button twice.

---

<b>Actions</b>	<b>Descriptions</b>
Right-click	Press the right button once. In many applications, this action displays a shortcut menu of context-sensitive choices.
Drag	Slide one finger while pressing the left button.
Scroll	Move your finger along the right edge of the touchpad to scroll vertically. Move your finger along the bottom edge to scroll horizontally. (The scroll function is available only with applications that support a touchpad scroll feature.)



---

The Mouse Properties dialog box lets you customize your mouse and touchpad features, such as touch sensitivity, motion, and buttons.

***To open the Mouse Properties dialog box:***

- 1 Click Start on the Windows taskbar, point to Settings, and then Control Panel.
- 2 Select Mouse. The Mouse Properties dialog box opens.

## **VAIO Action Setup**

VAIO Action Setup manages the settings for your computer's center Jog Dial™ control and Timer. An overview of some of the functions controlled by VAIO Action Setup is provided below. For more information on changing the settings using VAIO Action Setup, right-click the Jog Dial Utility icon  or  in the taskbar and click Help Topics.

## Using the Center Jog Dial Control

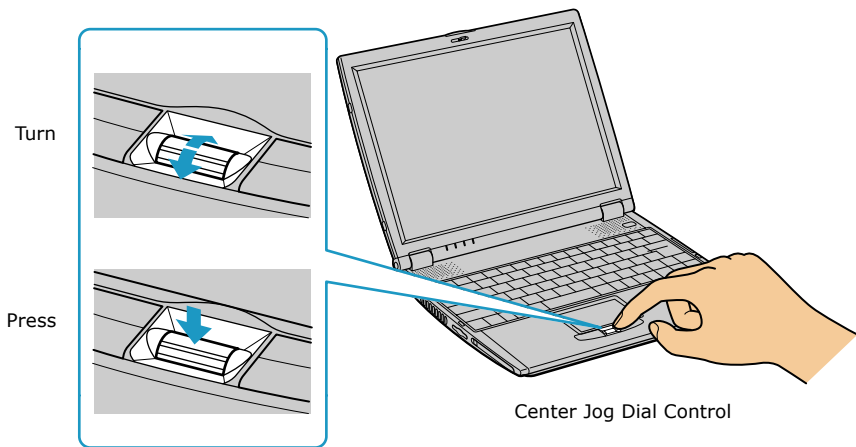

Your computer is equipped with a center Jog Dial™ control located below the touchpad and between the left and right buttons. The center Jog Dial control enables you to open an application, folder, or document from a predefined list by rotating and pressing the center Jog Dial control. In addition, when you press the center Jog Dial control, you can turn on your computer automatically and start the selected application or document.

### Center Jog Dial Control



The Jog Dial control window always appears in the display. It is either in the launcher mode or in the guide mode.

### Using the center Jog Dial control

This section explains how to use the center Jog Dial control. For information on how to change the settings of the center Jog Dial control, right-click the Jog Dial utility icon  or  in the task tray and click Help Topics.

## **Launcher mode**

The Jog Dial control window is in launcher mode until a software application is launched or the Jog Dial control window becomes active. When you select an item in the Jog Dial window and it is displayed between orange bars, you can press the center Jog Dial control to view a submenu of that item.

## **Using Launcher mode**

To use the center Jog Dial control, click the Jog Dial control window or the Jog Dial utility icon in the task tray. Alternatively, you can press the Ctrl key and the center Jog Dial control while the Jog Dial window is active to switch to launcher mode.

## **Jog Dial Launcher**

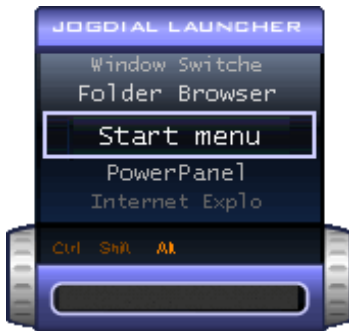

To select a desired item, proceed as follows:

- 1 Rotate the center Jog Dial control to select the item you want, then press the center Jog Dial control. The Jog Dial launcher window switches to guide mode and shows the function of the center Jog Dial control.

### **Jog Dial Guide**



- 2 Rotate or press the center Jog Dial control to use the desired function.
- 3 To select another item, repeat steps 1 through 3 above.

### **Using Guide Mode**

The Jog Dial control window is in the guide mode when software is in use and the software window is active. Depending on the software you are using, you can select items from the displayed list using the center Jog Dial control. You can switch between guide mode and launcher mode by pressing the Ctrl key and the center Jog Dial control.

The Jog Dial control window displays the function of the center Jog Dial control.

### **Using the center Jog Dial control with Sony software**

If Sony software that supports the center Jog Dial control is active, you can use the functions of the center Jog Dial control that are allocated to that software. For more information on functions allocated to software, see the software application's online Help.

## ***Using the center Jog Dial control with other software***

If the software you are using does not support the center Jog Dial control, you can still use the center Jog Dial control to scroll the window or adjust the window size.

### ***Using a dialog box***

When a window such as Screen Properties is active, the Dialog box is displayed in the Jog Dial window. You can select an item in the window by rotating the center Jog Dial control. Pressing the center Jog Dial control is the equivalent of pressing Enter or Select.

### ***Jog Dial Guide Dialog Box***





## Using a PC Card

Your computer includes one PC Card slot. A PC Card enables you to connect portable external devices, such as another hard disk drive, to your computer. It also lets you connect to a network using a PC Network Interface Card (NIC).

The PC Card slot accommodates one Type II PC Card. This slot is compatible with CardBus. You do not need to turn off your computer before inserting or removing a PC Card.

### To insert a PC Card

- 1 Insert the PC Card into the PC Card slot. Make sure the front label of the PC Card is facing up.

### Inserting a PC Card

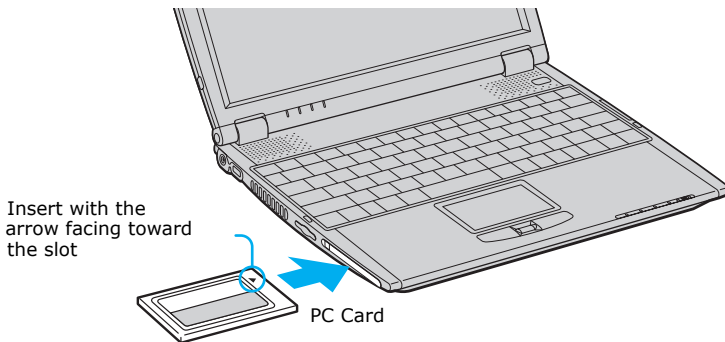

- 2 Push the PC Card gently into the slot. The PC Card is automatically detected by your system. The  Safely Remove Hardware icon appears in the taskbar.



**Do not force a PC Card into the slot. It may damage the connector pins.**

**If you have difficulty inserting a card, check that you are inserting the card with the correct orientation.**

**Do not carry your computer while the head of the PC Card is out of the slot. Pressure or shock may damage the connector pins.**

### **To remove a PC Card**

If your computer is turned on, follow these instructions. If your computer is turned off, skip to step number 5.

- 1 Close all applications that use the PC Card; otherwise, data may be lost.
- 2 Double-click the green arrow  icon in the taskbar.
- 3 Select an option in the Hardware devices box, and click Stop. The Stop a Hardware device window opens.
- 4 Click OK to confirm your selection, and then Close.
- 5 Press the PC Card Release button. The Release button pops out.
- 6 Press the PC Card Release button a second time (in some cases). Remove the card.

### **Removing PC Card**

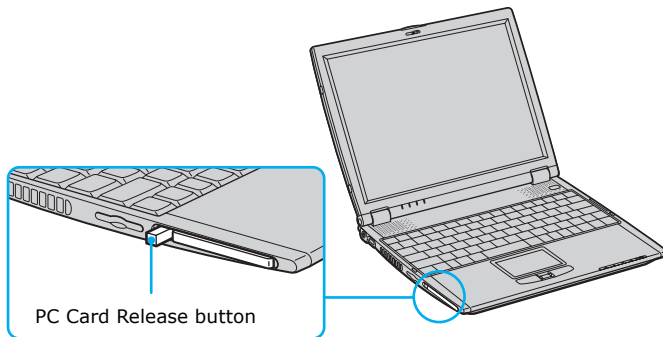

**Do not choose a USB disk or a Sony i.LINK® optical drive in the Stop a Hardware device dialog box.**

**If you removed a Sony i.LINK optical drive by mistake, disconnect the docking station and reconnect it. See “Disconnecting the computer from the docking station” for more information.**

### **Notes on using PC Cards**



- ❑ For some PC Cards, if you alternate between normal power operation and the Standby or Hibernate modes while the card is inserted, you may find that a device connected to your system is not recognized. Reboot your system to correct the problem.
- ❑ Some PC Cards may require that you disable idle devices when using the PC Card. You can use Sony Notebook Setup to disable devices. See “To display the Sony Notebook Setup screen” for more information.
- ❑ Make sure you use the most recent software driver provided by the PC Card manufacturer.
- ❑ If an exclamation mark (!) appears on the Device Manager tab in the System Properties dialog box, remove the software driver and then reinstall it.
- ❑ You may not be able to use some PC Cards or some functions of the PC Card with this computer. If you have difficulty inserting a PC Card, check that you are orienting the card correctly. See the manual that came with your PC Card for more information on its use.

## Using Memory Stick Media

Memory Stick® media is a compact, portable, and versatile recording medium that has a data capacity exceeding that of a floppy disk. The medium is specially designed for exchanging and sharing digital data with compatible products. Because it is removable, you can use the media for external data storage.

### Types of Memory Stick media

You can use these types of Memory Stick media with your computer:

- MagicGate™ Memory Stick\*  media (hereafter called MG Memory Stick media), which is provided with copyright protection
- Memory Stick†  media, which does not have the same copyright protection as MagicGate media

Some music files encoded with secure copyright protection may be stored on MG Memory Stick media but not on regular Memory Stick media. You can also use MagicGate media-compatible devices to record and playback music when they are connected to your computer.

You can store mixed data on the Memory Stick media. For example, you can copy an image on to MG Memory Stick media that already contains music.

### What is MagicGate media?

MagicGate media provides copyright protection that consists of authentication and encryption technology. Authentication technology ensures that protected content is only transferred between compliant devices and media. Protected content is recorded and transferred in an encrypted format to prevent unauthorized duplication or playback.

 MG Memory Stick media has the MG mark .

### Inserting Memory Stick media

When you insert a Memory Stick media, the Visual Flow™ application starts automatically. You can change this setting in VAIO Action Setup.

---

\* MagicGate Memory Stick and  are trademarks of Sony Corporation.

† Memory Stick and  are trademarks of Sony Corporation.

### **To insert a Memory Stick media**

- 1 Insert the Memory Stick media with the arrow facing upward and toward the Memory Stick media slot.

 Inserting the media in the wrong direction may damage the connector pins.

- 2 Carefully slide the Memory Stick media into the slot until it clicks in place. The Memory Stick media indicator light on the right of the computer briefly flashes.

### **Inserting Memory Stick Media**

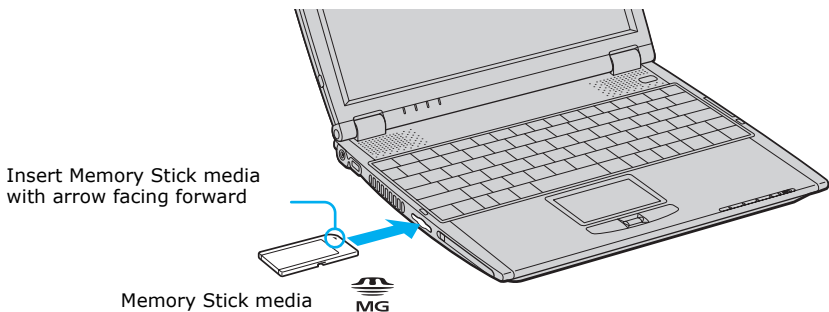

### **Viewing the contents of a Memory Stick media**

#### **To view the contents of a Memory Stick media**

- 1 Click the My Computer icon on your desktop. The My Computer window opens.
- 2 Click Removable Disk. A new window opens, displaying the Memory Stick media contents.

### **Removing Memory Stick media**

When you are not using a Memory Stick media, be sure to remove it from your computer.

### **To remove a Memory Stick media**

- 1 Make sure the Memory Stick media indicator light on the right of the computer is off.
- 2 Push the Memory Stick media in toward the computer.
- 3 When the Memory Stick media ejects, pull it out.

 Be careful when removing the Memory Stick media, as it may eject completely from the slot.

### **Write-protecting a Memory Stick media**

Memory Stick media is designed with a write-protect tab to protect valuable data from accidental erasure or overwriting. Move the tab to the right or left to set or release write-protection.

---

Write-protect off    Data can be saved on the Memory Stick media.

---

Write-protect on    Data can be read from but not saved on the Memory Stick media.

---

### **Using the Write-protect Tab**

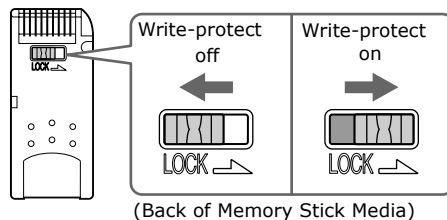

### **Formatting a Memory Stick media**

Memory Stick media is formatted for immediate use when you purchase it; however, if you need to reformat a Memory Stick media, follow the procedure below.



**Reformatting erases all current data that is stored on a Memory Stick media. Before you reformat, confirm that the media does not contain files you want to keep.**

***To reformat a Memory Stick media:***

- 1 Insert the Memory Stick media into the Memory Stick media slot. See “Inserting Memory Stick media” for more information.
- 2 Click Start in the Windows taskbar, and point to Programs, then Memory Stick Utility.
- 3 Select Memory Stick Formatter. The Memory Stick Formatter window appears.
- 4 Select an option from the Drive List, and click Start Format.

***Notes on Memory Stick media***

- When the write-protect tab of the Memory Stick media is set to LOCK, data cannot be recorded or erased.
- Before using Memory Stick media, back up important data.
- Wait a minimum of 10 seconds after the Memory Stick media finishes reading or writing data before removing the media.
- If the media is removed prematurely, a blue screen with an error message appears, prompting you to continue or exit. Reinsert the media into the slot and press the Enter key to continue. This allows the media to finish reading or writing data.
- You can enjoy video clips that you have recorded with Memory Stick media-compatible video camera recorders.
- The media slot accommodates one Memory Stick media at a time.
- You may copy images from a digital video camera using Memory Stick media.
- Only use MG Memory Stick media with copyright protected data such as music.
- Copyright protected music cannot be checked-out to any Memory Stick media other than MG Memory Stick media.

- ❑ Recorded music is limited to private use only. Using recorded music for any other purpose requires permission of the copyright holders.
- ❑ Sony is not responsible for music files that cannot be recorded from a CD or downloaded from other sources.
- ❑ Formatting Memory Stick media erases all data (including music data) previously saved to it. Before you format Memory Stick media, confirm that the media does not contain files you want to keep.
- ❑ Do not use the media in locations that are subject to static electricity or electrical noise.
- ❑ Do not touch the media connector with your finger or metallic objects.
- ❑ Do not attach labels other than the supplied label to a media.
- ❑ Do not bend, drop, or apply strong shock to the media.
- ❑ Do not disassemble or modify the media.
- ❑ Do not allow the media to get wet.
- ❑ Do not use or store the media in a location that is subject to:
  - ❑ Extremely high temperatures, such as in a car parked in the sun
  - ❑ Direct sunlight
  - ❑ High humidity or places with corrosive substances
- ❑ To prolong the life of the media, use the supplied storage case. See the instructions that came with your media for more information on its use.



## **Using Power Saving Modes**

When you use a battery as the source of power for your computer, you can use the power management settings to conserve battery life. In addition to the normal operating mode, which allows you to turn off specific devices, your computer has two distinct power saving modes: Standby and Hibernate. When using battery power, be aware that the computer automatically enters Hibernate mode when the remaining battery charge drops below 5 percent, regardless of the power management setting you select.

 If the battery level falls below 10 percent, you should either attach the AC adapter to recharge the battery or turn off your computer and insert a fully charged battery.

### **Normal mode**

Normal mode is the normal state of your computer when it is in use. The power indicator displays green when your computer is in this mode. To save power, you can turn off a specific device such as the LCD or the hard disk drive.

### **Standby mode**

In Standby mode the computer saves the current state of the system in RAM and switches off power to the CPU. The amber power indicator flashes in this mode.

#### **To activate Standby mode**

- 1 Press the key combination Fn + Esc.
- 2 Press any key to return to normal mode.

### **Hibernate mode**

In the Hibernate mode, the state of the system is saved on the hard drive and power is turned off. The power indicator is off in this mode.

### **To activate Hibernate mode**

- 1 Press the key combination Fn + F12, or press the power button and release it immediately. The “Save to Disk Manager” window appears and the computer enters Hibernate mode.

 Do not move the computer until its power indicator turns off.

Pressing the power button and releasing it immediately caused prior computer systems to enter Standby mode.

- 2 Press the power button to return to normal mode.

### **Notes on power saving modes**

- When returning from Hibernate mode, the system status stored on the hard disk is erased and the computer starts normally if you press the power button and hold it for more than 4 seconds.
- Standby uses more power than Hibernate.
- Standby requires less time than Hibernate to return to normal mode.

## Connecting a Telephone Line

You need to connect a telephone line to use online services and the Internet.

 In order to register your Sony VAIO® computer, register your software online, and use Sony Customer Support, you must connect the computer to a telephone line.

- 1 Gently peel back the rubber telephone jack cover. Pulling the telephone jack cover too hard or too far could damage it.

 Do not plug the telephone cable into the Ethernet port  located to the left of the telephone jack as this may damage your computer.

- 2 Plug one end of the telephone cable into the telephone jack, under the telephone jack cover. Make sure you insert the telephone cable from the rear of the computer and that the modular jack clicks into place.
- 3 Plug the other end into the wall jack.

### Plugging Telephone Cable into Telephone Jack

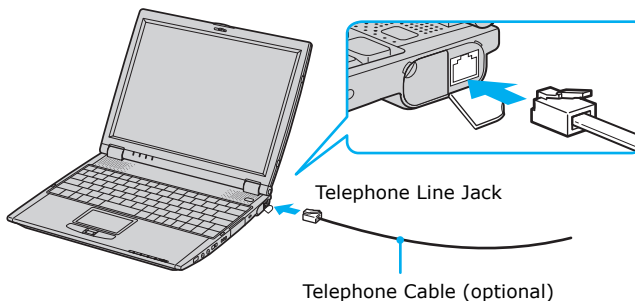



 Your computer does not work with party lines, cannot be connected to a coin-operated telephone, and may not work with multiple telephone lines or a private branch exchange (PBX). Some of these connections might result in excess electrical current and could cause a malfunction in the internal modem.

## Connecting to a LAN

You can connect your computer to 10BASE-T and 100BASE-TX-type Local Area Networks (LANs). For the detailed settings and devices needed to connect to the network, please ask your network administrator.

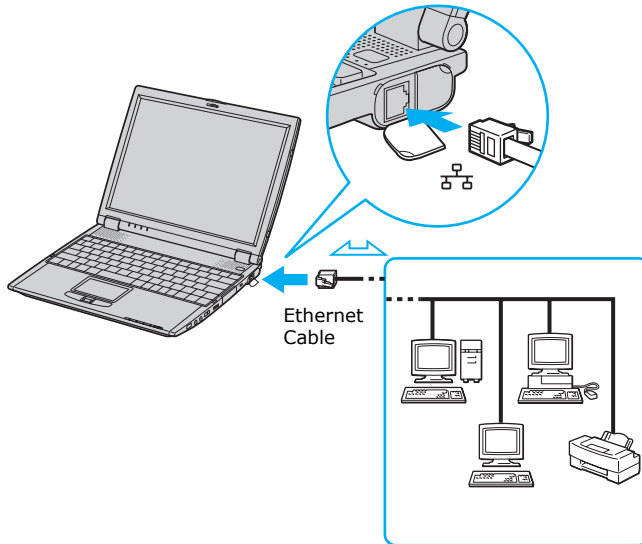
### Connecting to LAN



**Warning:** Only connect 10BASE-T and 100BASE-TX cables to the  Ethernet port. Do not connect any other type of network cable or any telephone line. Connecting cables other than those listed above may result in an electric current overload and could cause a malfunction, excessive heat, or fire in the port. To connect the unit to the network, contact your network administrator.

### Setting up your Ethernet connection

#### To connect to a network

- 1 Click Start on the Windows® taskbar, and point to Settings.
- 2 Select Network and Dial-up Connections.

- 3** Click the Make New Connection icon. The Network Connection Wizard appears.
- 4** Follow the on-screen instructions.

## **Connecting to a Wireless LAN**

Depending on the R505 model you purchased, your computer comes equipped with a built-in mini PCI card that allows for wireless connections. With Sony's Wireless Local Area Network (LAN) functionality, all compatible digital devices can communicate freely without cable connections. A Wireless LAN is a network in which a mobile user can connect to a LAN through a wireless (radio) connection. You can opt to purchase a Wireless LAN Access Point to set up a LAN.

### **Turning On Wireless LAN**

To enable Wireless LAN functionality, open the computer and move the Wireless LAN switch on the right to ON. The Wireless LAN indicator to the left of the switch lights up.

#### **Turning on wireless LAN function**

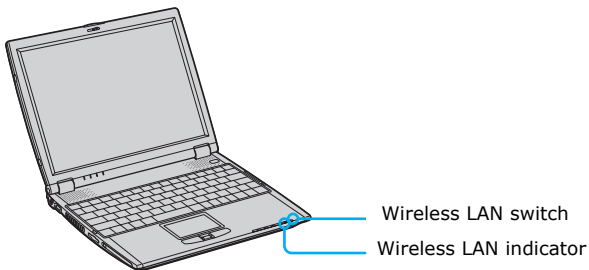

### **The Wireless LAN Access Point**

The Wireless LAN Access Point, which is also called the access point, is designed for building a Wireless LAN environment. If you purchase an access point, you can easily build a wireless LAN environment by plugging the access point into an AC power outlet and using the provided software with compatible devices. Because a wireless LAN configuration requires no wiring, you can operate multiple computers more freely than ever before.

You can also connect an access point to a telephone line, Integrated Services Digital Network (ISDN) router, cable modem, or Digital Subscriber Line (DSL) modem to share access to the Internet among multiple computers.

 For information on available Sony products, go to:  
<http://www.sonymstyle.com/wirelesslan>.

## ***Communication with an Access Point (infrastructure)***

An infrastructure network is one that extends an existing wired local network to wireless devices by providing an access point. The access point bridges the wireless and wired LAN and acts as a central controller for the Wireless LAN. The access point coordinates transmission and reception from multiple wireless devices within a specific range.

### ***Communicating via Wireless LAN Access Point***

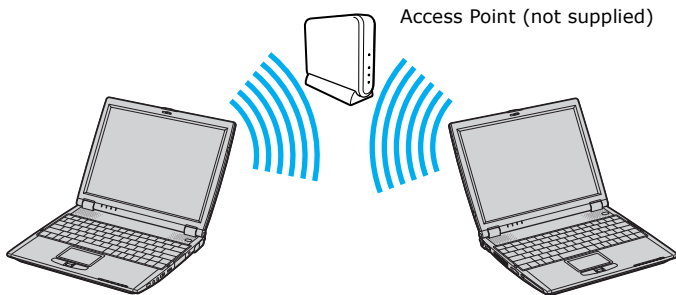

### ***To communicate with an Access Point***

- 1 Open the computer and move the Wireless LAN switch on the right to ON. The Wireless LAN indicator to the left of the switch lights up.
- 2 Click Start, and point to Settings.
- 3 Point to Control Panel, and select Wireless Network. The Add/Edit Configuration Profile window opens.
- 4 Click Add. The Edit Configuration window opens.
- 5 Type a profile name, and make sure Access Point is selected under Network Type.
- 6 Click Next.
- 7 Click Scan to select a network, and then click Next.

- 8 Click Enable Data Security if the access point was set up with an encryption key, and select either alphanumeric characters or hexadecimal, depending on your encryption key.
- 9 Type your key in the first box, and make sure “Key 1” is selected near the bottom of the screen.
- 10 Click Next.
- 11 Select a power management option, and click Next.
- 12 Click the check box next to “Renew IP Address when selecting this profile” to select it, and then click Finish.

### ***Communicating without an Access Point (peer-to-peer)***

A peer-to-peer network is one in which a local network is created only by the wireless devices themselves, with no other central controller or Access Point. Each device communicates directly with other devices in the network. You can set up a peer-to-peer network easily at home.

#### ***To communicate without an Access Point***

- 1 Open the computer and move the Wireless LAN switch on the right to ON. The Wireless LAN indicator to the left of the switch lights up.
- 2 Click Start, and point to Settings.
- 3 Point to Control Panel, and select Wireless Network. The Add/Edit Configuration Profile window opens.
- 4 Click Add. The Edit Configuration window opens.
- 5 Type a profile name, and use the drop-down menu to select Peer-to-Peer Group under Network Type.
- 6 Click Next.
- 7 Create a network name, and use the drop-down menu to select a channel number.
- 8 Click Next.



- 9 If you want to set up an encryption key so only those who know the key can access the network, then click the check box next to Enable Data Security, select either alphanumeric characters or hexadecimal (depending on your encryption key), and type a five digit key.
- 10 Click Next.
- 11 Click the check box next to “Renew IP Address when selecting this profile” to select it, and then click Finish.

### **Turning Off Wireless LAN**

Move the Wireless LAN switch on the right to the OFF position. The Wireless LAN indicator to the left of the switch shuts off.



**Turning off the Wireless LAN functionality while accessing remote documents, files, or resources may result in data loss.**

### **Notes on using Wireless LAN**

- ❑ Sony Wireless LAN devices support the IEEE 802.11b standard. Devices connecting to a Wireless LAN using the IEEE 802.11a standard cannot connect to devices using the IEEE 802.11b standard.
- ❑ Wireless LAN communication occurs on divided frequency bands known as channels. Third-party Wireless LAN Access Point channels may be preset to different channels from Sony devices.
- ❑ If using a Wireless LAN Access Point, refer to connectivity information contained in those instructions.



# Connecting Peripheral Devices

*You can add functionality to your computer by connecting it to a variety of peripherals, as discussed in the following sections:*

- ❑ Connecting the Docking Station
- ❑ Using the Floppy Disk Drive
- ❑ Using an Optical Disc Drive
- ❑ Connecting an i.LINK Optical Disc Drive
- ❑ Connecting a Parallel Port Printer
- ❑ Connecting a USB Printer
- ❑ Connecting an External Display
- ❑ Connecting a USB Device
- ❑ Connecting an i.LINK Device
- ❑ Connecting VAIO Computers
- ❑ Connecting External Speakers
- ❑ Connecting an External Microphone
- ❑ Expanding Your Computer Capabilities

## Connecting the Docking Station

Your computer may come with a PCGA-DSM51 docking station, depending on the model you purchased. Optional docking stations are also available. Both Sony docking stations provide you with the following:

- ❑ A floppy disk drive.
- ❑ An optical drive.
- ❑ A back panel that enables you to connect additional peripherals to your computer, as shown below.

### Back Panel

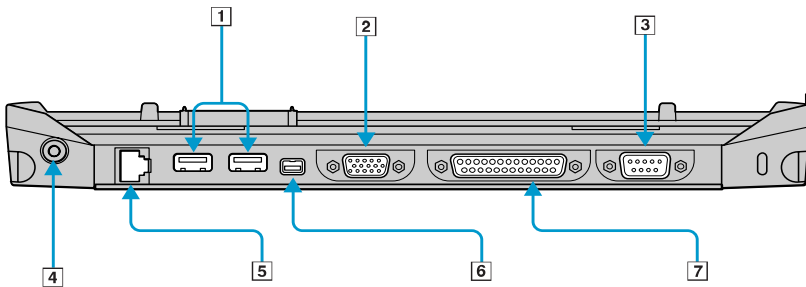

- 
- |   |           |   |  |
|---|-----------|---|--|
| 1 | USB ports | 5 | Ethernet/Network port<br>(10BASE-T/100BASE-TX) |
|---|-----------|---|--|
- 
- |   |                    |   |                                   |
|---|--------------------|---|-----------------------------------|
| 2 | VGA (monitor) port | 6 | i.LINK®* (IEEE 1394)<br>S400 port |
|---|--------------------|---|-----------------------------------|
- 
- |   |             |   |              |
|---|-------------|---|--------------|
| 3 | Serial port | 7 | Printer port |
|---|-------------|---|--------------|
- 
- |   |            |  |  |
|---|------------|--|--|
| 4 | DC In port |  |  |
|---|------------|--|--|
-

\* i.LINK is a trademark of Sony used only to designate that a product contains an IEEE 1394 connection. The i.LINK connection may vary, depending on the software applications, operating system and compatible i.LINK devices. All products with an i.LINK connection may not communicate with each other. Refer to the documentation that came with your compatible i.LINK device for information on operating conditions and proper connection. Before connecting compatible i.LINK PC peripherals to your system, such as a CD-RW or hard disk drive, confirm their operating system compatibility and required operating conditions.

**Left**

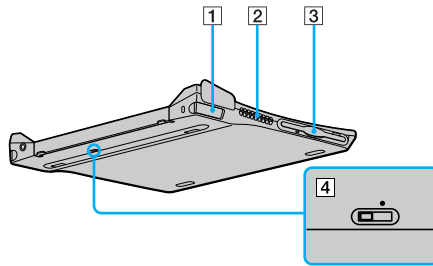

---

**1** Left lever

**3** Floppy disk drive

**2** Air vent

**4** i.LINK\* network switch

---

\* i.LINK is a trademark of Sony used only to designate that a product contains an IEEE 1394 connection. The i.LINK connection may vary, depending on the software applications, operating system and compatible i.LINK devices. All products with an i.LINK connection may not communicate with each other. Refer to the documentation that came with your compatible i.LINK device for information on operating conditions and proper connection. Before connecting compatible i.LINK PC peripherals to your system, such as a CD-RW or hard disk drive, confirm their operating system compatibility and required operating conditions.

**Right**

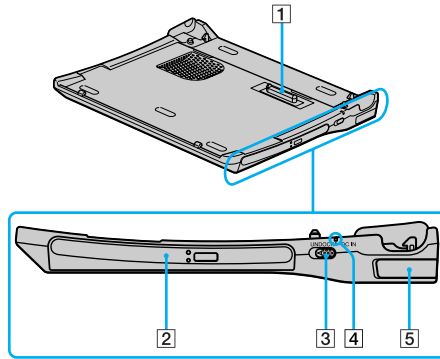

- 
- |   |                           |   |                 |
|---|---------------------------|---|-----------------|
| 1 | Docking station connector | 4 | DC In indicator |
| 2 | Optical drive             | 5 | Right lever     |
| 3 | UNDOCK switch             |   |                 |
- 

**Connecting the computer to the docking station**

You may connect your computer to the docking station as long as it is not in a power saving mode, i.e., Standby or Hibernate. Connecting the computer while it is in a power saving mode may result in data loss or a computer malfunction. Note the following before connecting your computer to the docking station:

- Disconnect the VGA, USB, AC, and Ethernet devices from your computer. Leaving these devices connected while you connect the docking station could damage them.
- Ensure that the battery is installed. If you install a charged battery, you can connect the docking station while the computer is on.

**To connect your computer to the docking station**

- 1 Plug one end of the AC adapter cable into the DC In port of the docking station and the other end into an AC outlet. The LED of the DC In port switches on.
- 2 Holding the computer with the front side facing you, insert the two holes on the front of the computer into the two corresponding latches protruding from the front side of the docking station.

**Latching the Computer to the Docking Station**

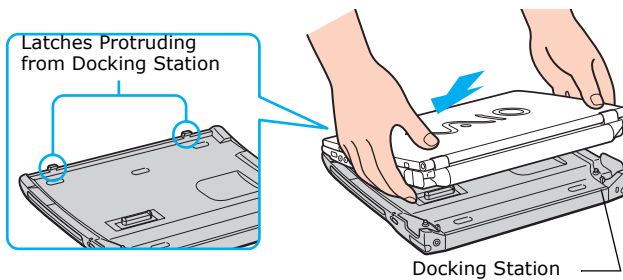

- 3 Firmly press down the two rear corners of the computer until it clicks into place and is securely fastened to the docking station.



**Be careful not to press the top of the computer too strongly. The LCD display may become damaged.**

### ***Securing the Computer to the Docking Station***

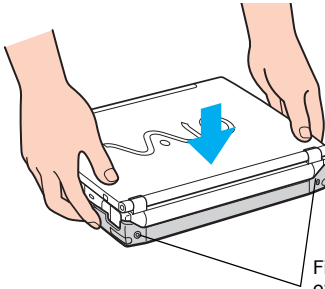

Firmly press down the two rear corners of the computer until it clicks into place.

### ***Disconnecting the computer from the docking station***

You may disconnect the computer from the docking station when the computer is off or on; however, do not disconnect the computer from the docking station while the docking indicator is on, while the computer is in Standby or Hibernate mode, or while battery power is low. If you do attempt to disconnect the docking station in any of these three states, you may lose data or the computer may malfunction.



When the battery is low, turn off the computer before you disconnect the docking station.

Follow one of the procedures below to disconnect the docking station when the computer is off or on.

#### ***Disconnecting the docking station when the computer is off***

- 1 Disconnect all peripheral devices (i.e., i.LINK® devices) from the computer and the docking station.
- 2 Remove all objects placed on top of the computer.
- 3 Pull out the two release levers on either side of the rear corners of the docking station, to release the computer from the docking station.



### **Releasing the Computer from the Docking Station**

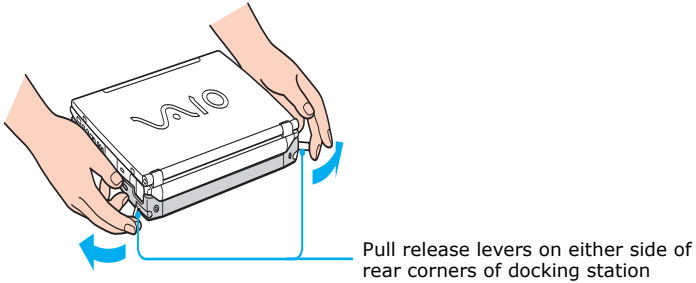

- 4 Remove the computer from the docking station, while moving the computer slightly back to disengage it from the two front latches of the docking station.

### **Removing the Computer from the Docking Station**

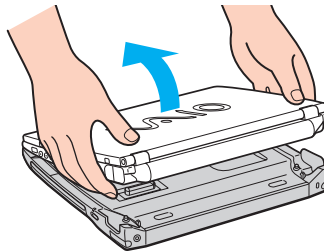

### **Disconnecting the docking station when the computer is on**

You can use the Start menu in the Windows® taskbar or the UNDOCK switch on the docking station to disconnect your computer from the docking station while the computer is on.

**To disconnect the docking station from the Start menu**

- 1 Click Start in the Windows® taskbar.
- 2 Select Eject PC and wait for a message to appear, telling you it is safe to undock the computer.



**Wait for the docking indicator to switch off before undocking the computer.**

**Docking Indicator**

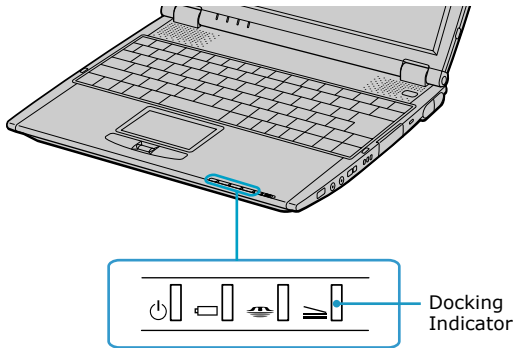

- 3 Release and remove your computer. See “Disconnecting the docking station when the computer is off” for instructions.

**To disconnect the docking station, using the UNDOCK switch**

- 1 Slide the UNDOCK switch on the right toward the front of your computer.
- 2 Wait for a message to appear, telling you it is safe to undock your computer.

**UNDOCK switch**

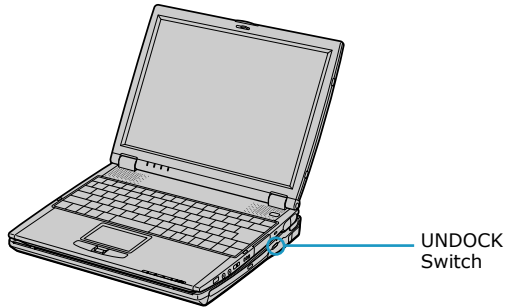

- 3 Release and remove your computer as described in the “Disconnecting the docking station when the computer is off” section.

## Using the Floppy Disk Drive

If your computer came with a docking station, you may use the built-in floppy disk drive. However, if your computer did not come with a docking station or you chose not to utilize the docking station drive, you may connect an optional, external PCGA-UFD5 floppy disk drive to one of the two USB ports, identified by the  $\Psi$  symbol, on your computer.



**Do not use an optional PCGA-UFD5 floppy disk drive while your computer is connected to the docking station.**

### To insert a floppy disk

- 1 Hold the floppy disk with the label side facing up.
- 2 Gently push the floppy disk into the drive until it clicks into place.

### Inserting Floppy Disk

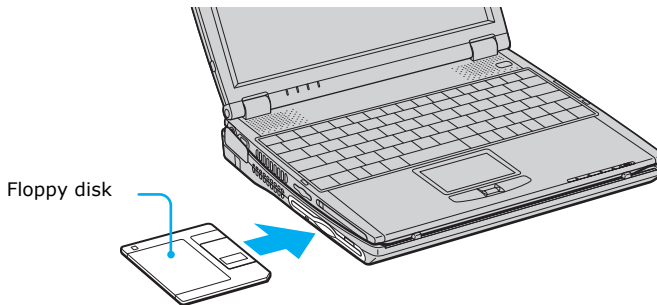

### To remove a floppy disk

- 1 Make sure the LED indicator light on the floppy disk drive is off.
- 2 Press the Eject button.

### Removing Floppy Disk

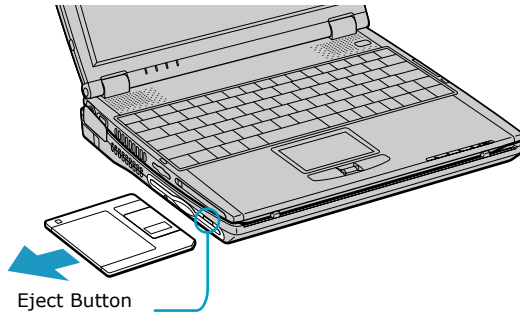

 Do not push the Eject button when the LED indicator is turned on; otherwise, you may lose data.

### Notes on handling floppy disks

- Do not open the shutter manually and touch the surface of the floppy disk.
- Keep floppy disks away from magnets.
- Keep floppy disks away from direct sunlight and other heat sources.

## Using an Optical Disc Drive

You may use the PCGA-DSM51 CD-RW/DVD Docking Station or the PCGA-DSM5 CD-RW/DVD Docking Station if your computer came with a docking station. Both Sony docking stations have a built-in optical drive. If your computer did not come with a docking station or you chose not to utilize the docking station drive, you may connect an external optical drive (such as PCGA-CRWD2) to the i.LINK port.



**Do not use an optional PC Card optical drive while your computer is connected to the docking station.**

### To insert a disc

When the computer is in Standby or Hibernate mode, you cannot insert a disc because the disc tray will not open. See “Controlling Power Management” for more information.

- 1 Press the Eject button to open the optical drive. The disc tray slides out.

### Ejecting the tray

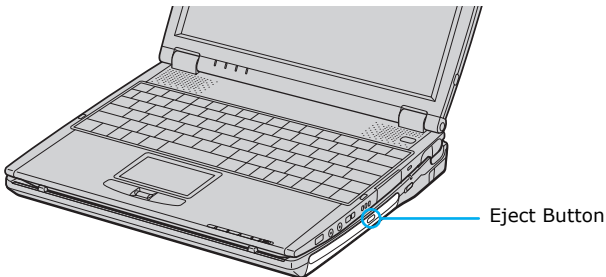

- 2 Place the disc on the tray with the label side facing up. For DVDs that can be played on both sides, the side of the disc facing up is the side that plays.
- 3 Push the disc onto the hub until the disc clicks into place.



**If the disc is not secured, it could damage the optical drive and you may not be able to open the tray.**

### **Inserting an optical disc**

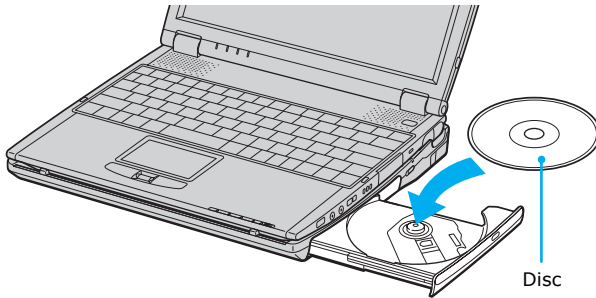

- 4 Close the tray by pushing it gently. The LED indicator on the drive flashes while your computer reads data from the disc.

### **To remove a disc**

When the computer is in Standby or Hibernate mode, you cannot remove a disc because the disc tray will not open. See “Controlling Power Management” for more information.

- 1 After you finish using a disc, wait until the LED indicator turns off.
- 2 Press the Eject button to remove the disc.
- 3 If the disc does not come out when you press the Eject button, turn off the computer and insert a thin, straight object (such as a paper clip) into the manual eject hole.

### **Playing a DVD**

To play a DVD, you may use the optical disc drive and the preinstalled WinDVD® software. For more information on WinDVD, see the Help menu in the WinDVD application.

 Before you use the optical disc drive to play a DVD, close any open applications.

Your optical drive can read most DVD-R media. When you are ready to play a DVD, read the suggestions below to maximize your video viewing experience.

- ❑ When using an optional optical drive or an optional PC Card drive to play a DVD, set the power management profile to DVD. You can also set the power management profile to Automatic Profile Selection if the display is not clear when using other profiles.

 Automatic Profile Selection sets the power management profile to DVD whenever a DVD is inserted into the drive. See “Controlling Power Management” for more information.

- ❑ When playing a DVD with an optional PC Card drive, you may use battery power; however, connect the computer to AC power when using the docking station to play a DVD.
- ❑ Some DVD videos may allow limited operations or functions, or present sound noise or dropped frames.



**Some discs recorded at 20 or 24 bits may produce noise while playing. If you have audio devices connected, this may damage your hearing and the speakers. Reduce the volume before playing a DVD.**

**Do not switch between LCD and external display once a DVD is playing. This may cause a malfunction, and you may need to restart the DVD software.**

**Do not switch the power saving modes while you are playing the DVD.**

**Do not install the software that comes with PCGA-DVD51/A drive.**

## ***Playing an audio CD***

### ***To play an audio CD***

- 1 Insert the CD into the optical disc tray. The Audio CD window opens.
- 2 Select either Play Audio CD using Windows Media Player or Play Audio CD using SonicStage.
- 3 Click OK.

### ***To write data to a CD-R or CD-RW disc***

You can use Sony SonicStage™ software to write data to a CD-R or CD-RW disc. To create a CD-R disc that is readable in a CD-ROM drive, make sure you finish the writing process before ejecting it.



- ❑ For optimal writing speed, deactivate the screen saver and exit anti-virus software before writing data to a disc.
- ❑ For best results, use CD-Rs that are compatible with 8x speed.



**Do not use the Eject PC option in Windows® or press the UNDOCK switch on the docking station while writing data to a CD-R or CD-RW. Doing so may severely damage your computer.**

**Do not put your computer into power saving mode while writing data to a CD-R or CD-RW disc.**

**Do not strike or shake the computer while writing data to a disc.**

**Memory-resident disc utilities, such as the screen saver and virus checker, may cause unstable operation or data loss. Deactivate these utilities (if they are active) before writing data to a disc.**

**Always use the AC adapter as the power source for your computer when you are writing data to a CD-R or CD-RW. Using battery power may result in data transfer failure.**

### ***Notes on CD and DVD discs***

- ❑ Do not drop or bend the disc.
- ❑ Do not touch the surface of the disc. Fingerprints and dust on the surface of a disc may cause reading errors.
- ❑ For normal cleaning, hold the disc by its edge and use a soft cloth to wipe the surface from the center out.
- ❑ If the disc is badly soiled, moisten a soft cloth with water, wring it out well, and use it to wipe the surface of the disc from the center out. Wipe off any remaining moisture with a dry, soft cloth.
- ❑ Do not use solvents such as benzine, thinner, commercially available cleaners or anti-static spray, as they may damage to the disc.

## **Connecting an i.LINK Optical Disc Drive**

You can use an optional i.LINK®\* optical disc drive with your computer. This Sony VAIO® computer is preinstalled with software that enables you to create CDs and play DVD movies. The i.LINK optical disc drive draws power from the computer through the power cable that is integrated with the VAIO computer Peripheral Cable. This peripheral cable connects to both the i.LINK port and peripheral cable DC Out jack on the left side of the computer.†

 If you use an optional drive when your computer is running on battery power, the battery life will be shorter.

### **Connecting an i.LINK optical disc drive**

Use a VAIO® Computer Peripheral Cable (supplied with the i.LINK drive) to connect the optical disc drive to the computer.

 Before connecting or disconnecting this drive, close any active applications to help prevent data loss.

### **To connect an i.LINK optical disc drive**

- 1 Turn on power to the computer. Insert the L-shaped plug of the VAIO® Computer Peripheral Cable into the matching jack on the rear of the i.LINK

---

\* i.LINK is a trademark of Sony used only to designate that a product contains an IEEE 1394 connection. The i.LINK connection may vary, depending on the software applications, operating system and compatible i.LINK devices. All products with an i.LINK connection may not communicate with each other. Refer to the documentation that came with your compatible i.LINK device for information on operating conditions and proper connection. Before connecting compatible i.LINK PC peripherals to your system, such as a CD-RW or hard disk drive, confirm their operating system compatibility and required operating conditions.

† If you connect and use an optional drive when your computer is running on battery power, the battery life will be reduced.

drive. Secure the plug by turning the screw on the cable connector clockwise.

### Connecting i.LINK optical disc drive

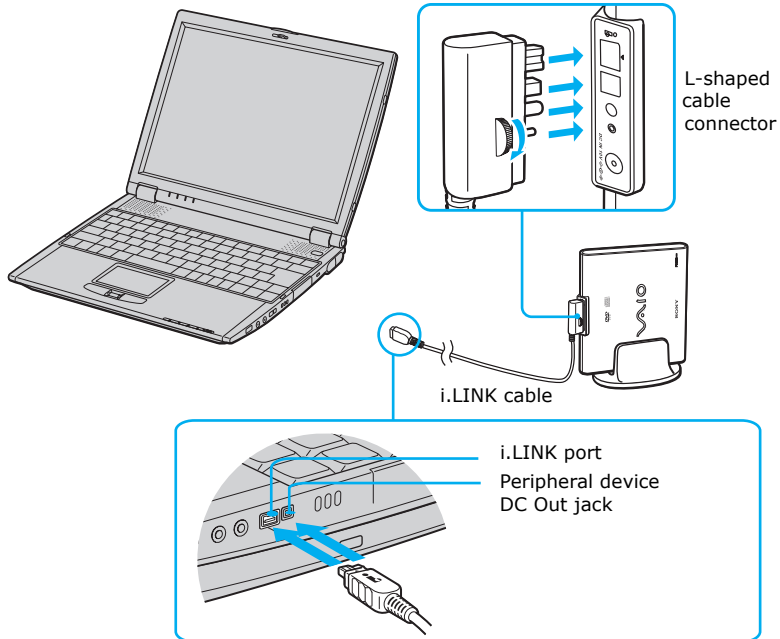

- 2 Insert the straight-shaped, two-prong plug of the VAIO® computer peripheral cable into both the computer's i.LINK port and peripheral device DC Out jack.
- 3 The i.LINK drive's power indicator lights up, and the computer will automatically detect and identify the connected drive.
- 4 Click My Computer on the desktop to verify that an icon for the i.LINK optical disc drive has been added in the window.

 The Sony i.LINK optical disc drive is compatible only with certain Sony VAIO® PCG series computers preinstalled with Microsoft® Windows®.

### **Notes on using i.LINK optical disc drives**

- ❑ You can use the supplied Application Recovery and System Recovery CDs with an i.LINK optical disc drive. See “Application and System Recovery CDs” for more information.
- ❑ Do not use an optional i.LINK optical disc drive and an optional optical disc drive with PC Card at the same time. Connecting both drives may cause a system malfunction.

## Connecting a Parallel Port Printer

If your computer came with a docking station, you can connect a Windows® operating system-compatible parallel port printer to the docking station. However, if your computer did not come with a docking station, see “Connecting a USB Printer” for information on connecting a printer to your computer.

 Turn off the computer before connecting peripherals. In normal use, you should turn on the peripherals before turning on your computer.

### To connect a parallel port printer

- 1 Locate the Printer port, identified by the  symbol, on the docking station.
- 2 Plug the printer cable (not supplied) into the Printer port.
- 3 Make sure the Printer setting in the Sony Notebook Setup software is properly set. See “Displaying the Sony Notebook Setup Screen” for more information.
- 4 See the manual supplied with your printer for more information on its installation and use

### Connecting a Printer to the Docking Station

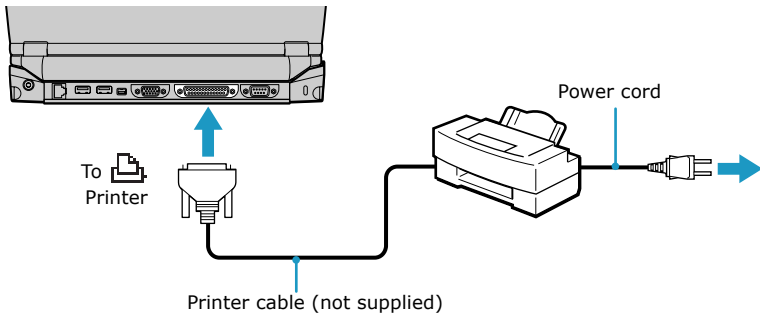

 If your printer stops functioning after resuming from a power saving mode, see “Troubleshooting the Printer” for more information.

## Connecting a USB Printer

You may connect a Windows® operating system-compatible Universal Serial Bus (USB) printer to either of your computer's two USB ports.

 To use a printer, first install the driver software that came with your printer.

### To connect a USB printer

- 1 Locate the USB ports, identified by the  $\Psi$  symbol, on your computer and printer.
- 2 Plug the USB printer cable into one of the two USB ports.
- 3 Make sure the Printer setting in the Sony Notebook Setup software is properly set. See “Displaying the Sony Notebook Setup Screen” for more information.
- 4 See the manual supplied with your printer for more information on its installation and use.

### Connecting a USB Printer

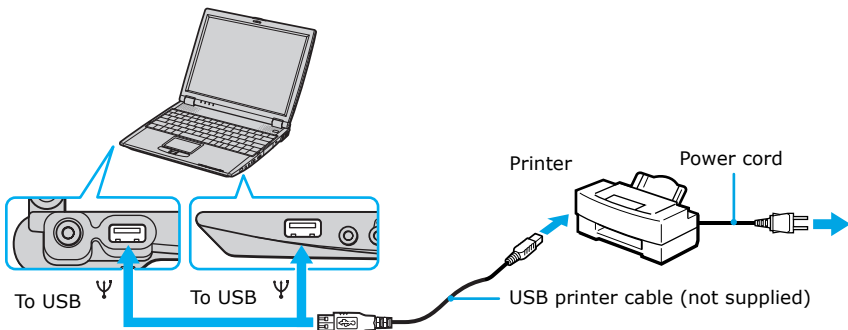

 If your printer stops functioning after resuming from a power saving mode, see “Troubleshooting the Printer” for more information.

## ***Connecting an External Display***

You can connect a computer display (such as a monitor or a projector) to your computer or docking station.

 The docking station is supplied with selected models only.

### ***To connect a monitor to your computer***

- 1** Make sure the external display is plugged into an AC outlet.
- 2** Open the monitor port panel on the right side of the computer.
- 3** Plug the display cable (VGA connector) into the monitor port.
- 4** Restart your computer.
- 5** Press the key combination Fn + F7 to change the display to monitor.
- 6** See the manual that came with your computer display for more information on its installation and use.

### Connecting Monitor to the Computer

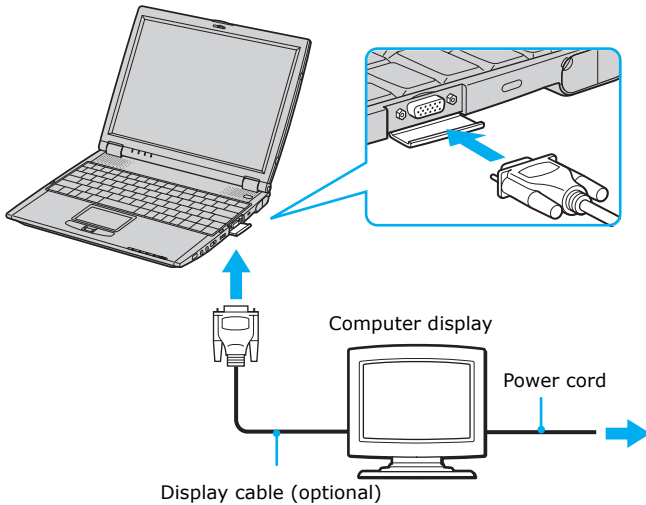

 You cannot use the monitor port on your computer when the docking station is connected to the computer; however, you can use the monitor port on the docking station.

### To connect an external display to your docking station

- 1 Make sure the external display is plugged into an AC outlet.
- 2 Open the rear panel of the docking station, and locate the monitor port.
- 3 Plug the display cable into the monitor port.
- 4 Make sure the cable is connected to the external display.
- 5 Restart your computer.
- 6 Press the key combination **Fn + F7** to change the display to monitor.
- 7 See the manual that came with your computer display for more information on its installation and use.



**Connecting Monitor to the Docking Station**

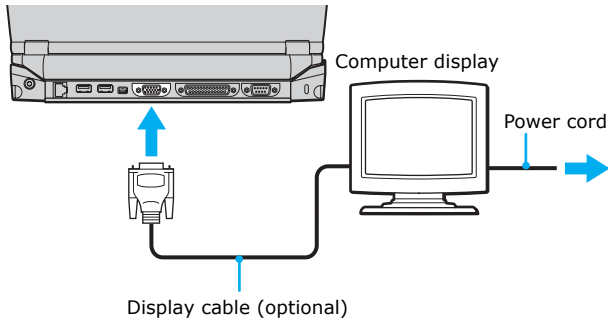

**To connect a projector (such as a Sony LCD Projector) to your computer**

- 1 Make sure the projector is plugged into an AC outlet.
- 2 Open the monitor port panel on the right side of the computer.
- 3 Plug the RGB signal cable into the monitor port, and make sure it is connected to the projector.
- 4 Plug the audio cable into the green Headphone jack on the right side of the computer, and make sure it is connected to the projector.
- 5 Press the key combination **Fn + F7** to change the display to projector.
- 6 See the manual that came with your projector for more information on installation and operation.

### Connecting Projector to the Computer

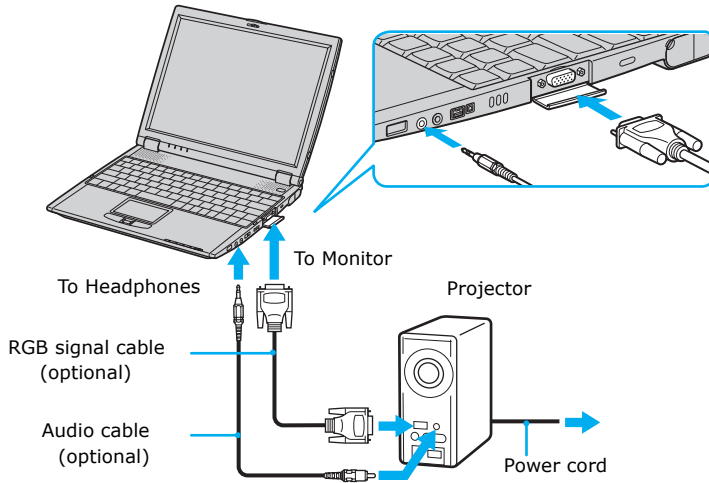

#### **To connect a projector (such as a Sony LCD Projector) to your docking station**

- 1 Make sure the projector is plugged into an AC outlet.
- 2 Open the rear panel of the docking station, and locate the monitor port.
- 3 Plug the RGB signal cable into the monitor port, and make sure it is connected to the projector.
- 4 Plug the audio cable into the green Headphone jack on the right side of the computer, and make sure it is connected to the projector.
- 5 Plug the audio cable into the green Headphone jack on the right side of the computer.

### Connecting Projector to the Docking Station

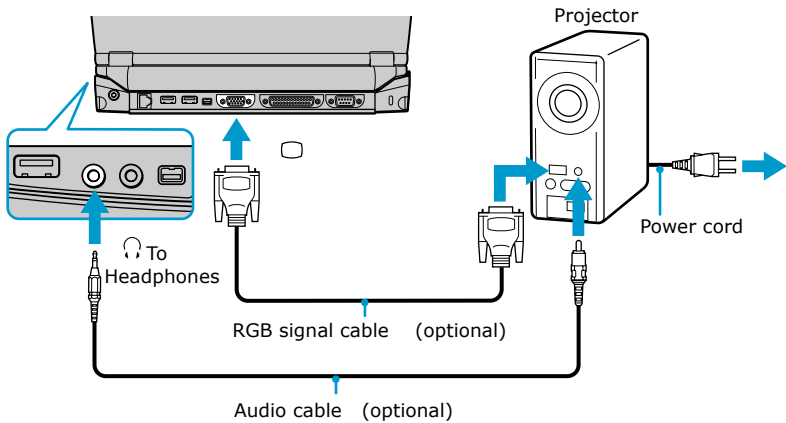

- 6 See the manual that came with your projector for more information on installation and operation.

 You cannot use the Monitor port on your computer when the docking station is connected to the computer.

### To select a display

When you connect an external display to the Monitor port, press the key combination **Fn+F7** to toggle the output between the Liquid Crystal Display (LCD), the external monitor, or both devices. See “Selecting the Display Mode” for more information.

## Connecting a USB Device

You can connect a variety of Universal Serial Bus (USB) devices such as an external mouse, keyboard, speaker, and microphone to your computer.

### To connect a USB device to your computer

- 1 Locate a USB port, identified by the  $\Psi$  symbol, on the computer. There are two USB ports on the computer, one on the right side and one on the left side.
- 2 Plug one end of the USB cable into a port and the other end into the USB device.

### Connecting USB Device to the Computer

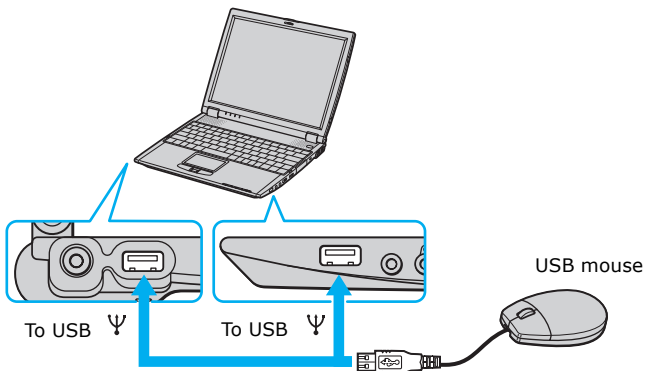

### To connect a USB device to the docking station

- 1 Open the rear panel of the docking station, and locate the USB ports, identified by the  $\Psi$  symbol. There are two USB ports located on the back side of the docking station.
- 2 Plug one end of the USB cable into a port and the other end into the USB device.

### Connecting USB Device to the Docking Station

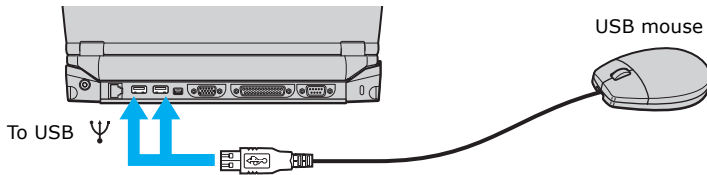

You can use an optional Sony USB mouse, such as a PCGA-UMS1 series, with this computer. Since the USB mouse software driver is preinstalled in the computer, you simply plug the USB mouse into the USB port to use it. One USB port supports one USB device.

 See the manual that came with your USB device for more information on its installation and use.

## **Connecting an i.LINK\* Device**

Your VAIO computer includes an  i.LINK® (IEEE 1394) S400 port, which connects to a compatible i.LINK device such as a digital video camera recorder.

### ***To connect a digital video camera recorder***

Plug one end of an i.LINK cable (not supplied) into the  S400 port on the right side of the computer and the other end into the DV In/Out port on the digital video camera recorder. If your digital video camera recorder includes a Memory Stick® media slot, you can copy images from it to your computer via a Memory Stick media. Copy images to the Memory Stick media and insert the media into the Memory Stick media slot on your computer. See “Using Memory Stick Media” for more information on using Memory Stick® media

---

\* i.LINK is a trademark of Sony used only to designate that a product contains an IEEE 1394 connection. The i.LINK connection may vary, depending on the software applications, operating system, and compatible i.LINK devices. All products with an i.LINK connection may not communicate with each other. Refer to the documentation that came with your compatible i.LINK device for information on operating conditions and proper connection. Before connecting compatible i.LINK PC peripherals to your system, such as CD-RW or hard disk drive, confirm their operating system compatibility and required operating conditions.

### Connecting Digital Video Camera Recorder

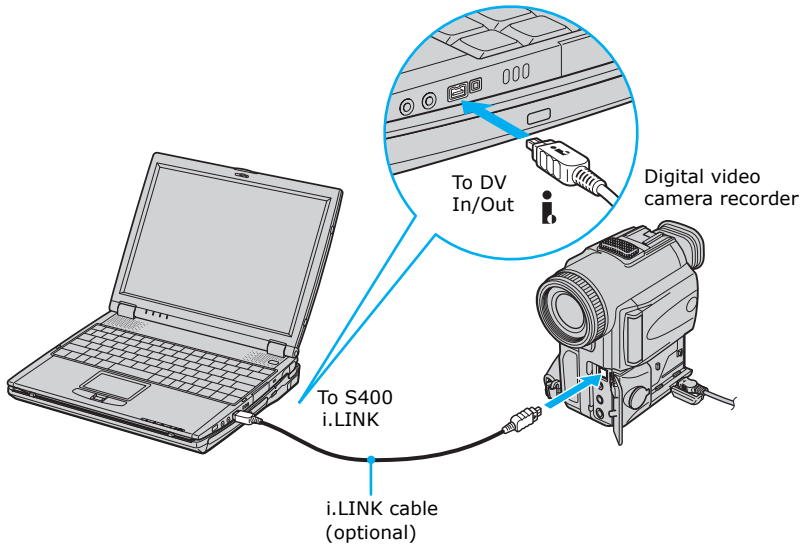

### Notes on i.LINK devices

- ❑ The above figure displays connection to a Sony digital video camera; your digital video camera recorder may need to be connected differently.
- ❑ Only Sony digital video cameras and ports labeled “DV In/Out” or “i.LINK” are compatible i.LINK devices.
- ❑ See the manual that came with your digital video camera recorder for more information on installation and use.
- ❑ The i.LINK port does not supply power to external devices. If the external device requires power from the i.LINK port, you cannot use the device with your computer.
- ❑ The VAIO computer supports transfer rates up to 400 Mbps, however, the actual transfer rate is the lowest transfer rate of the external device.
- ❑ The i.LINK features available may vary depending on the software applications you use. See the documentation that came with your software for more information.

- ❑ You can connect a digital video camera to the i.LINK port on your computer or the i.LINK port on the optional port replicator. When a camera is connected to the i.LINK port on the computer, you should not connect any other devices to the i.LINK port on the port replicator. When a camera is connected to the i.LINK port on the port replicator, you should not connect any other devices to the i.LINK port on the computer.
- ❑ i.LINK\* cables compatible with your VAIO computer include cables with the following part numbers: VMC-IL4415A (a 1.5-meter cable with a 4-pin connector at each end), VMC-IL4615A (a 1.5-meter cable with a 4-pin connector at one end and a 6-pin connector at the other). You can purchase these cables from your local retailer, through the Sony VAIO® Direct Web site (<http://vaio.sonymstyle.com>) or by calling 1-888-315-7669 (toll free).





## Connecting VAIO Computers

You may use an optional i.LINK®\* cable to connect your VAIO® computer to another VAIO computer that has the preinstalled Microsoft® Windows® operating system or the Sony Smart Connect software preinstalled. You may use an i.LINK cable (not supplied) to connect the two systems and then use one computer to edit, copy, or delete files on the other computer. You can also print from a printer that is attached to either computer.

To connect VAIO computers that do not have the latest Windows® operating system, Smart Connect software may be necessary. Consult the Sony Web site for support options (<http://www.sony.com/pcsupport>).

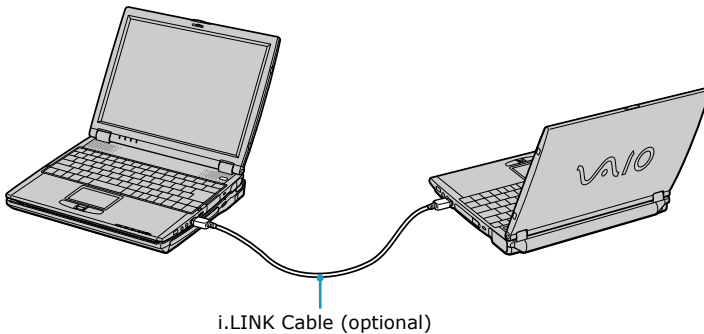
### Connecting with an i.LINK cable



 When you connect two VAIO computers, you must assign each computer a unique name. The computers can be identified by this unique name when the two computers are networked together.

\* i.LINK is a trademark of Sony used only to designate that a product contains an IEEE 1394 connection. The i.LINK connection may vary, depending on the software applications, operating system, and compatible i.LINK devices. All products with an i.LINK connection may not communicate with each other. Refer to the documentation that came with your compatible i.LINK device for information on operating conditions and proper connection. Before connecting compatible i.LINK PC peripherals to your system, such as CD-RW or hard disk drive, confirm their operating system compatibility and required operating conditions.

### ***If your computer is connected to the docking station***

If you want to exchange data with another computer using the optional i.LINK cable and your computer is connected to the docking station (supplied with selected models), perform the following:

- 1 Disconnect your computer from the docking station as described in the “Disconnecting the computer from the docking station” section.
- 2 Disconnect the AC adapter and all cables from the docking station.
- 3 Using a thin pen tip, set the i.LINK network switch on the bottom of the docking station to the side marked ●.



**Do not set the i.LINK network switch when the computer is on. The computer will malfunction.**

#### ***i.LINK Network Switch***

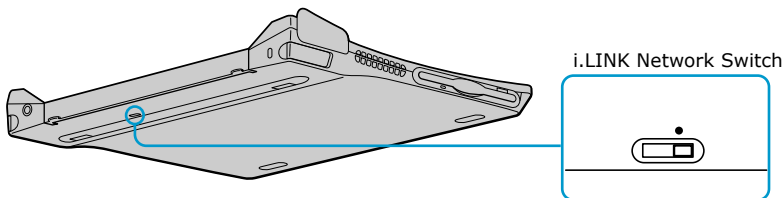

- 4 Connect the docking station to your computer as described in the “Connecting the computer to the docking station” section.
- 5 Turn on the computer, and use the i.LINK cable to connect your computer to another computer.
- 6 After you have finished the “smart connect” session tasks, proceed as follows:
  - Disconnect your computer from the docking station.
  - Disconnect the i.LINK cable and all other cables from the docking station.

- ❑ Set the i.LINK network switch to the unmarked side.

## Connecting External Speakers

You can connect external speakers to your computer to enhance the sound quality of your computer. See the manual that came with your speakers for more information on its installation and use.



**Do not place floppy disks on the speakers. The magnetic field of the speakers may damage the data on the floppy disks.**

### *Before connecting your external speakers*

- 1 Verify that your speakers are designed for computer use.
- 2 Turn down the volume of the speakers before you turn them on.

### *To connect your external speakers*

- 1 Locate the green Headphone jack on the right side of your computer.
- 2 Plug the speaker cable into the Headphone jack.

### *Connecting Speakers to the Headphone Jack*

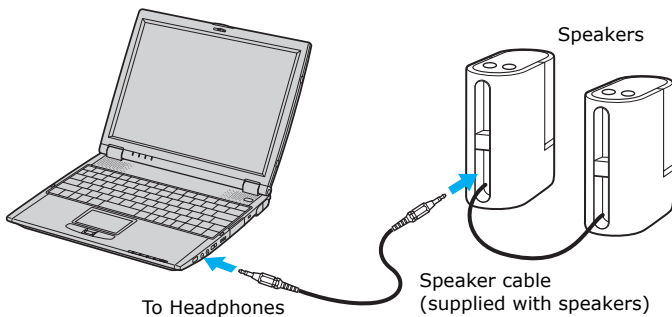

## Connecting an External Microphone

You can use an external microphone to enhance the quality of the sound input. See the manual that came with your microphone for more information on its installation and use.

 Verify that your microphone is designed for computer use. The microphone should be compliant with the plug-in power microphone.

### To connect an external microphone

- 1 Locate the red Microphone jack on the right side of your computer.
- 2 Plug the microphone cable into the Microphone jack.

### Connecting Microphone to Microphone Jack

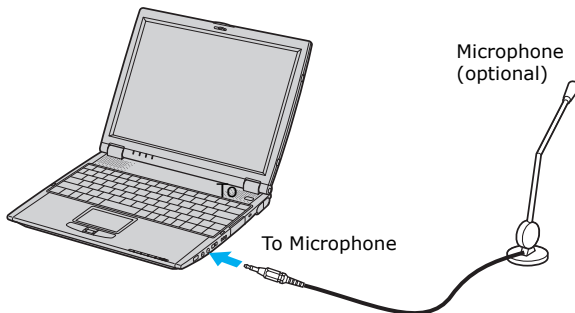

## ***Expanding Your Computer Capabilities***

The following peripheral devices can be connected to your computer, to expand the capabilities of your computer and enhance its versatility to meet your various business or personal needs:

- A Personal Digital Assistant (PDA)
- A Wireless LAN Access Point
- A Wireless LAN PC Card

### ***Personal Digital Assistant***

A handheld PDA is the quintessential personal planner and entertainment center that fits in your pocket. With a PDA, you can easily perform the following functions:

- Enter your schedule details in the calendar and view them by the day, week, or month, and even set an alarm to remind you of important events.
- Keep your contact names, addresses, telephone numbers, and other details in the address book, and find them when you need them.
- Add tasks to the To Do List, prioritize them, and assign them due dates.
- Synchronize your data with the software on your computer to back up your data.
- Track expenses when you are out of the office, then transfer the data to your computer.
- Exchange data with your computer.

### ***Wireless LAN Access Point***

The Wireless LAN Access Point is designed for building a wireless Local Area Network (LAN) environment. The Access Point comes with the Wireless LAN PC Card and required software. You can easily build a wireless LAN environment by plugging the Access Point into an AC power outlet, installing the Wireless LAN PC Card in your computer, and using the provided software. Because a wireless LAN configuration requires no wiring, you can operate multiple computers more freely than ever before.

You can also connect your Access Point to a telephone line, Integrated Services Digital Network (ISDN) router, cable modem, or Digital Subscriber Line (xDSL) modem to share access to the Internet among multiple computers.

 For information on wireless LAN, go to <http://www.sonystyle.com/wirelesslan>.





# Customizing Your VAIO Computer

*The following sections briefly describe how to change your computer's default settings:*

- ❑ Displaying the Sony Notebook Setup Screen
- ❑ Controlling Power Management
- ❑ Displaying Battery Information
- ❑ Selecting the Display Mode

## Displaying the Sony Notebook Setup Screen

### To display the Sony Notebook Setup screen

- 1 Click Start on the Windows taskbar, and point to Settings, then Control Panel.
- 2 Select Sony Notebook Setup. The Sony Notebook Setup screen appears.

### Sony Notebook Setup Screen



- 3 Select the tab for the item you want to change. See “Sony Notebook Setup tabs” for more information.
- 4 After you finish making your changes, click OK.

## **Sony Notebook Setup tabs**

---

<b><i>Tab</i></b>	<b><i>Description</i></b>
About This Computer	Display system information, including memory capacity, serial number, and BIOS version.
Printer	Select printer port mode settings.
Initial Setting	Change the volume of the sounds that play while the operating system is loading. Select the order of drives and devices from which you want to load the operating system. You can specify the hard drive as well as other drives inserted into your computer.
Touchpad	When you connect an optional mouse to the Serial port of your computer, you can make your touchpad inactive. You can also customize the settings of your mouse using the mouse utility.
Power On Password	Set the password to secure your computer.
Enable Ports	Enable or disable ports. Disabling ports releases resources to the system. To change the serial settings, click Advanced on the Basic/Advanced tab.
Basic/Advanced	Switch between Advanced mode (additional screens with advanced settings) and Basic mode of display.

---

 For more information about each option, click Help on the Sony Notebook Setup screen to display the Help file.

## **Controlling Power Management**

The PowerPanel™ utility allows you to control the power settings of your computer and provides key information about system activity and battery life. The following sections briefly describe how to conserve your computer's battery power. You can also refer to PowerPanel help for more detailed information. To activate a profile or command, see “Displaying Battery Information” for more information.

### **Viewing the Power Management status icons**

The Power Management status icons are displayed in the taskbar at the lower right side of your screen. Move the pointer over the icons to see the tool tip that displays information about the active profile. The CPU status icon indicates the performance level of the CPU. Double-clicking the CPU status icon also displays the PowerPanel battery information.

#### **To activate your Power Management toolbar**

- 1 Right-click on the taskbar at the bottom of the screen.
- 2 Select Toolbars from the pop-up menu, and then click Power Management. The Power Management toolbar appears on the taskbar.

#### **To change the Power Management profile**

- 1 Right-click the battery icon on the taskbar, and then select Profiles.
- 2 Choose a new profile from the pop-up list. See “Power Management profiles” for a description of available options.  
If you don't see any new icons on the taskbar, double-click “Power Management” on the taskbar, and the toolbar appears.

The current profile icon is the first icon farthest to the left, and its appearance changes depending on which power management profile is currently selected.

To change the power management profile, click the current profile icon, then select a new profile from the pop-up list. See “Power Management profiles” for a description of available options. To select another power management profile, click that icon in the Power Management toolbar.

 When you use the battery pack to power your computer, your system selects the Maximum Battery Life power management profile by default. If you select a different power management profile while using battery power, the new profile is selected automatically the next time you use the battery pack to power your computer.

Refer to PowerPanel help for information on customizing the Power Management toolbar.









### ***To customize Power Management settings***

You can customize power management settings, such as the system timer and the brightness of the screen.

- 1 Right-click the Battery icon on the Window taskbar.
- 2 Select Edit/Create Profiles from the menu.
- 3 In the left panel, click a profile in which you want to change the settings.
- 4 In the right panel, double-click an item in which you want to change the settings.
- 5 Select an option from the drop-down list.
- 6 Click the File menu, then click Save.
- 7 Click the File menu, then click Exit.

### ***Power Management profiles***

The PowerPanel™ utility provides several predefined power management profiles. Each profile consists of a group of power management settings that are designed to meet specific power management goals—ranging from maximum power management to no power management. You can change the settings for any of the predefined profiles (except for the Disable Power Management profile), or you can create your own profile to suit your portable computing needs. The predefined profiles are:

<b>Icon</b>	<b>Description</b>
	<b>Maximum Performance</b> Provides the best system performance while still conserving power.
	<b>Maximum Battery Life</b> Provides power saving features to give you maximum battery life and good performance. It slows the computer and puts it into Standby mode after a specified time period.
	<b>Disable Power Management</b> Turns off all power management features such as Standby and Hibernate modes. You can not change the settings of this profile.
	<b>AC Power</b> The power management state when AC power is in use. Similar to the Power Management Off setting. Power Management automatically loads the AC profile unless you disable this feature.
	<b>Games</b> Disables the display and the Hard Disk Standby timer.
	<b>Presentation</b> Keeps the display on at all times while it conserves power. This option is ideal for slide show presentations. You can establish settings for LCD (Video) Standby, Hard Disk Standby, and Standby to optimize power management for your system.
	<b>Camera</b> Optimizes performance and power requirements for camera usage.
	<b>DVD</b> Optimizes performance and power requirements for DVD usage.

---

**Icon**

**Description**



**Word Processing**

Optimizes power management with longer timeouts on the hard disk and display screen. You can also establish settings for LCD (Video) Standby, Hard Disk Standby, and Standby to optimize power management for your system.



**Spreadsheet**

Optimizes performance and power requirements for spreadsheet applications.



**Communications**

Extends battery life by initiating a quick display timeout. The Internal modem remains powered. You can also establish settings for LCD (Video) Standby, Hard Disk Standby, and Standby to optimize power management for your system.





**Automatic Profile Selection**

Automatically switches to a profile suitable for active applications.

---

**Power Management commands**

PowerPanel™ also provides power management commands that you can use to activate specific power management functions and to control power for a specific device. You can use these commands to override a profile setting or initiate an immediate action.

<i>Icon</i>	<i>Description</i>
	<b>Standby</b> Puts the system into Standby mode, a power management state that saves the state of the system and peripheral devices in memory (RAM). Power consumption reduces to a minimum, and the system remains on. To return the system to the active state, press any key or the power button on your computer.
	<b>Hibernate</b> Provides for the lowest level of power consumption. The system writes the state of the system and peripheral devices to the hard disk and turns off the system power. To return the system to the original state, use the power button to turn on power. The system saves the data in the Save to Disk Partition on the hard drive.

---

### ***Conserving battery power***

When using the computer with a battery, the LCD display and the hard drive can be set to switch off automatically to conserve battery power.

See “Power Management profiles” for more information.



## Displaying Battery Information

You can display detailed information for each of the batteries in your computer. The following sections briefly describe how to display your computer's general battery information. Refer to PowerPanel™ Help for more detailed information.

### To activate the battery information toolbar

- 1 Right-click on the taskbar at the bottom of the screen.
- 2 Select Toolbars from the pop-up menu, then click Battery Information. The Battery Information toolbar appears on the taskbar.

You can also view the total capacity remaining in the battery by placing the pointer over the battery status icon in the task tray on the lower right side of the screen.

### Battery Information Toolbar



- ❑ **Percentage indicator** — Displays the percentage of the remaining battery capacity.
- ❑ **Time indicator** — Displays estimated time (hours/minutes) remaining before the battery fully drains, also referred to as the time-to-empty.

### Battery icon descriptions

---

Battery Icon	Battery Status
--------------	----------------

---



Charging

---

---

**Battery Icon      Battery Status**

---



Fully charged



Discharging



No battery

---

**Displaying detailed battery information**

Double-click the battery icon on the task tray to display the Battery Information window. The screen appears displaying the Battery tab, which contains information such as the estimated time-to-empty and charging time.

**Battery Information Window**

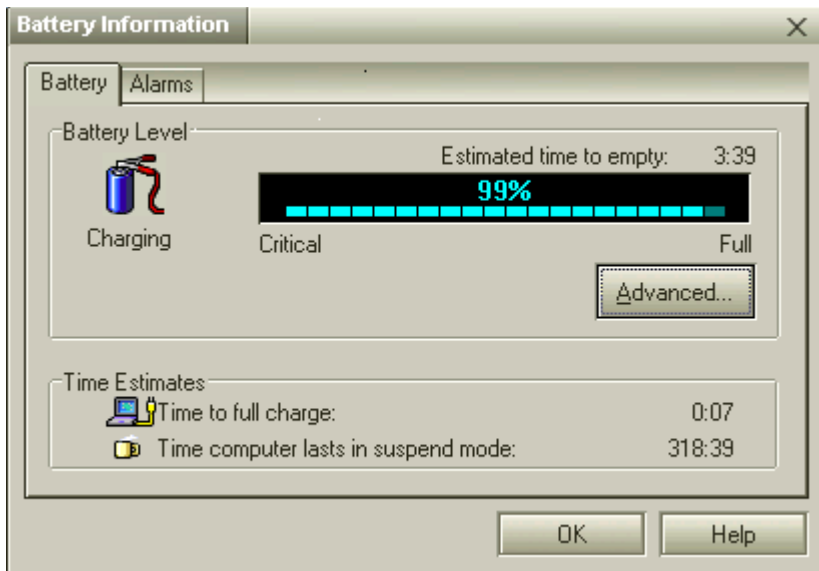

***To customize the Battery Information toolbar and alarm system***

You can customize the Battery Information toolbar to suit your portable computing needs, including modifications to the alarm settings. Refer to PowerPanel™ Help for more information.

## Selecting the Display Mode

This computer uses the Intel® video controller, which enables you to select the desired display when the computer is connected to an external monitor. When you connect an external display, you can switch the display mode between your computer's LCD display and the external monitor.

 See "Connecting an External Display" for more information.

### **To select the display mode**

- 1 Make sure the external display you are connecting to is turned on and the VGA connector is securely in place.
- 2 On your computer, press the key combination Fn+F7 to switch the display mode. The image that was on your computer's monitor should appear on the external display.

If the display mode does not switch, do the following:

- 1 Click Start, and then point to Settings.
- 2 Point to Control Panel, and select the Display icon. The Display Properties window opens.
- 3 Click the Settings tab, and then Advanced.
- 4 Click the Monitor tab. In the Monitor Type box, use the drop-down arrow to select the external monitor option.

 You may not be able to display the computer LCD screen and an external display or projector at the same time, depending on the types of computer displays and projectors you are using.

Turn on the computer after you turn on the peripheral devices.

### **To change the window design of Sony software**

- 1 Click Start in the Windows taskbar, and then point to Settings.
- 2 Point to Control Panel, and select UI Design Selector.
- 3 Click << or >> and select the desired design.

- 4 Click Apply. The UI Design Selector window design changes. The window design for your Sony software will match the UI Design Selector window.

 This feature is available with UI Design Selector-compatible software only.



# Adding Memory

*In the future you may want to install memory modules to expand the functionality of your computer. See the Specifications sheet supplied with your computer for the amount of preinstalled memory. Expansion memory modules are available as options. For memory upgrades and information about which memory modules to use, refer to the Specifications sheet. This section provides you with information on removing and replacing a memory module:*

- ❑ Precautions and Procedures
- ❑ Installing a Memory Module
- ❑ Removing a Memory Module
- ❑ Viewing Memory

## Precautions and Procedures

The procedures described below assume familiarity with the general terminology associated with personal computers and with the safety practices and regulatory compliance required for using and modifying electronic equipment. Personal injury or equipment damage may result from failure to take these precautions.



**Sony recommends memory upgrades be performed by an authorized Sony Service Center. To find the nearest center or agent, see <http://www.sony.com/pcsupport>.**

**Observe the proper safety precautions when installing memory modules in your computer. See the bulleted list below. Use care when adding memory. Mistakes when installing or removing a memory module may cause a malfunction.**

- ❑ Disconnect the system from its power source and from any telecommunications links, networks, or modems before you open the system.
- ❑ Electrostatic discharge (ESD) can damage disk drives and other components. Perform the procedures described below only at an ESD workstation. If such a station is not available, do not work in a carpeted area, and do not handle materials that produce or hold static electricity (cellophane wrappers, for example). Ground yourself by maintaining contact with an unpainted metal portion of the chassis while performing the procedure.
- ❑ Do not open the memory module package until you are ready to install the module. The package protects the module from ESD.
- ❑ Use the special bag for preventing ESD or use aluminum foil when you store the memory module.

### Typical expansion memory configuration

<b>Total System Memory (MB)</b>	<b>On board (MB)</b>	<b>Slot (MB)</b>
256	256	0
384	256	128
512*	256	256



- \* The 512 MB memory configuration may require the removal and replacement of original factory-installed memory module.

## **Removing a Memory Module**

### ***To remove a memory module***

- 1** Turn off your computer and disconnect all peripheral devices, such as your printer.
- 2** Unplug the computer and remove the battery packs.
- 3** After the computer has cooled, loosen and remove the two screws with the ←• mark located on the bottom of your computer. Use an appropriate screwdriver.
- 4** Slide the LCD lock lever and lift the cover. Slide the keyboard toward the LCD display, then lift it away slightly.
- 5** Lift the keyboard from the LCD display side, then gently turn it over on the touchpad space. Be careful not to detach the cable when lifting the keyboard.
- 6** Touch a metal object (such as the connector panel on the back of your computer) to discharge any static electricity.
- 7** Slide the memory module out of the slot.
- 8** Gently replace the keyboard, then press it into your computer. Be careful not to detach the cable when lifting the keyboard.
- 9** Close the computer cover, then tighten the screws on the bottom of the computer.

## Installing a Memory Module

### To install a memory module

- 1 Turn off your computer and disconnect all peripheral devices, such as your printer.
- 2 Unplug the computer and remove the battery packs.
- 3 After the computer has cooled, loosed and remove the two screws with the ←• mark located on the bottom of your computer. Use an appropriate screwdriver.

### Screws on Bottom of Computer

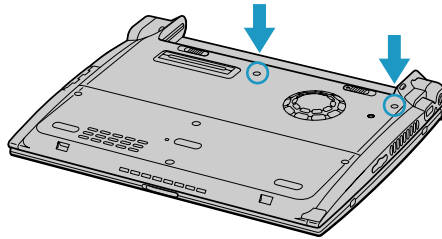

- 4 Slide the LCD lock lever and lift the cover. Slide the keyboard toward the LCD display, then lift it away slightly.

### **Lifting the Keyboard**

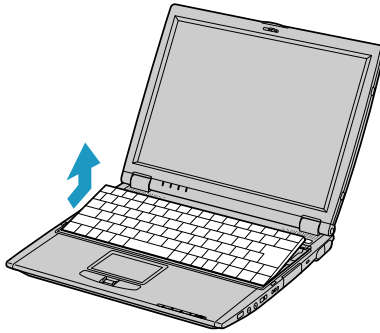

- 5 Lift the keyboard from the LCD display side, then gently turn it over on the touchpad space. Be careful not to detach the cable when lifting the keyboard.

### **Turning the Keyboard**

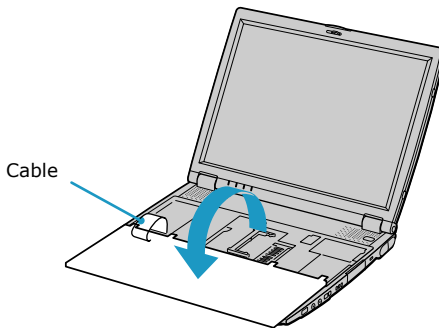

- 6 You must remove the existing memory module before you can install a new module. See “Removing a Memory Module” for instructions.
- 7 Touch a metal object (such as the connector panel on the back of your computer) to discharge any static electricity.
- 8 Remove the new memory module from its packaging.
- 9 Slide the memory module into the empty slot.

- 10 Press the module into place until it clicks.

**Installing the Memory Module**

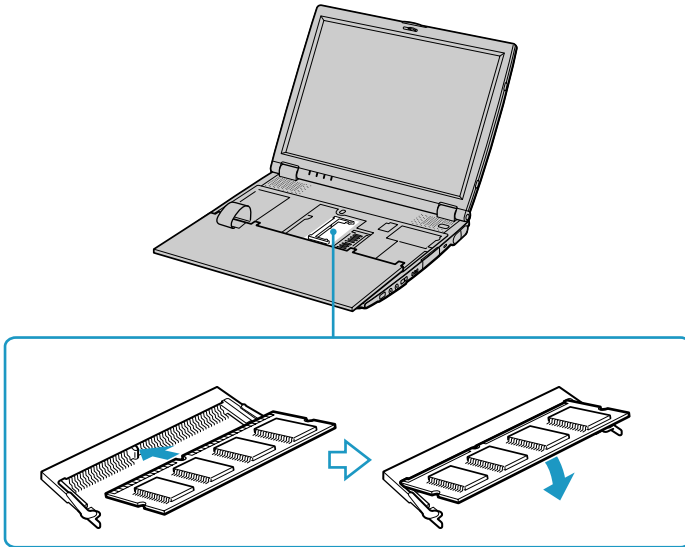

- 11 Gently replace the keyboard, then press it into your computer. Be careful not to detach the cable when lifting the keyboard.
- 12 Close the computer cover, then tighten the screws on the bottom of the computer.

## Viewing Memory

### *To view the amount of memory*

- 1 Restart the computer.
- 2 Click Start on the Windows® taskbar, then Settings, and then Control Panel.
- 3 Select Sony Notebook Setup. The Sony Notebook Setup window appears.
- 4 Make sure the About This Computer tab is open. Memory information is listed in the System Information box.

 The amount of memory displayed in the Sony Notebook Setup screen is not always correct. The video adapter uses some system memory, and that amount of memory does not appear as part of the total memory shown in the Sony Notebook Setup screen.

# *About the Software on Your Computer*

*Your VAIO® computer is ready to help you work, play, learn, and communicate as soon as you turn it on. This section offers the following information:*

- ❑ Overview of the Software on Your Computer
- ❑ Software Support Information
- ❑ Sony Service Center

## **Overview of the Software on Your Computer**

Your computer may not be supplied with all of the software listed below, depending on the configuration you purchased. Preinstalled software may not be identical to retail versions or include supporting documentation.

### **Adobe® Acrobat® Reader®**

*Adobe Systems Inc.*

Acrobat Reader software allows you to view, navigate, and print electronic documents in Adobe's Portable Document Format (PDF), an open file format that is intended to preserve the fidelity of documents created on all major computer platforms.

### **ArcSoft PhotoPrinter® 2000 Pro**

*ArcSoft, Inc.*

ArcSoft PhotoPrinter Pro software is an easy-to-use, yet advanced printing program that lets you quickly lay out multiple images in multiple sizes on a single sheet of paper. ArcSoft PhotoPrinter Pro software offers a wide selection of templates including landscape, portrait, free-style, mixed sizes, custom templates and more. The application includes enhancement tools and special effects for improving photos while giving you the ability to add text to any image. With ArcSoft PhotoPrinter 2000 Pro software you can create business cards, handouts, calendars, mailing labels, and much more.

### **Adobe® Photoshop® Elements**

*Adobe Systems Inc.*

Using state-of-the-art image editing tools, you can unleash your artistic ability and create digital images for print, e-mail and posting to the Web. The versatile image capturing options allow you to start working with digital and traditional photos immediately. Explore endless creative possibilities for your personal images with Adobe Photoshop Elements software.

### **Adobe® Premiere® LE (On selected models)**

*Adobe Systems Inc.*

Adobe Premiere LE software offers interface and editing tools for producing movies for video, multimedia, or the Web. View source clips and edited footage simultaneously on-screen. You can create your own personal video clips that are up to three hours in length, with complete audio-video synchronization.



### **America Online®**

*America Online, Inc.*

America Online is a popular Internet online service. Stay in touch with family and friends with easy-to-use e-mail. Manage your personal finances, get the latest news and sports scores, and chat with thousands of others who share your interests.

### **DigitalPrint**

*Sony Electronics Inc.*

This image management software makes it fun and easy to edit, import, and organize your digital pictures in a photo album for rich digital printing to any standard color laser or ink-jet printer. DigitalPrint can also be used to make custom CD labels for your audio CDs.

### **Drag'n Drop CD/DVD**

*DigiOn, Inc., and Easy Systems Japan Ltd.*

Drag'n Drop CD/DVD software is designed to be the most simple application available to create CDs and DVDs. You can create your own audio or data CDs and audio, data, or video DVDs that can be read in most audio CD players, personal computers, or DVD players. With Drag'n Drop CD/DVD software, you can also back up CDs and DVDs.

### **DVgate™**

*Sony Electronics Inc.*

Connect a digital video camera recorder to the i.LINK® port and capture your own video clips and still images. You can edit clips from your video, add new clips, and combine clips into new movie segments. You can also save your images in a variety of popular file formats.

### **EarthLink Network Total Access®**

*EarthLink, Inc.*

An Internet Service Provider that supplies access, information, and assistance to its customers, introducing them to the Internet. Member benefits include e-mail, newsgroups, a Personal Start Page, free storage space for your personal Web site, a member magazine, and 24-hour technical support.

### **Microsoft® Office XP Professional**

*Microsoft Corp.*

Microsoft Office XP software redefines the relationship between people and software by providing a smarter, simpler way of working. New Office XP software features include context-sensitive smart tags, enhanced formatting options, and more, that enable you to continually integrate additional services into Office and access information anytime.

### **Microsoft® Office XP Small Business Edition**

*Microsoft Corp.*

With Microsoft Office XP system you'll find a powerful new technology that will help you get work done more quickly by providing real-time, context-sensitive options for important actions, from formatting to error correction. Task panes consolidate important tasks into a single integrated view, enabling you to conduct searches, launch and format documents, and view the contents of your Clipboard from one location.

### **Microsoft® Word**

*Microsoft Corp.*

Microsoft Word makes it easy to create common Web, e-mail, and print documents for use around the world. It embraces HTML as a first-class file format and extends Word's ease-of-use to the Web and e-mail. Word also extends that ease-of-use to international users, making it easy to create multilingual documents.

### **MovieShaker™**

*Sony Electronics Inc.*

Sony's original MovieShaker software creates personal movies that have transitions, background music, and text. Just import your video clips and "shake" with a click of the mouse. Your personal movies are easy to create and fun to share with family and friends.

### **PC-Cillin® 2000**

*Trend Micro, Inc.*

PC-Cillin provides portable, easy-to-use, real-time antivirus security at your computer's entry point (beaming, synchronization, Internet access) to defend against potential threats hidden inside files, e-mail, or on the Web.

### **PicoPlayer™**

*Sony Electronics Inc.*

PicoPlayer software is a video player utility that enables you to use Giga Pocket™ Personal Video Recorder functions on a computer that does not have Giga Pocket Personal Video Recorder installed. You can play Video Capsules created by Giga Pocket Personal Video Recorder, and, if a Giga Pocket Server is available on your home network, watch TV streamed from the Giga Pocket Server and remotely control the Giga Pocket Server's TV programming functions.

### **PictureGear™**

*Sony Electronics Inc.*

This image management software displays images from your hard drive, a Sony digital still camera, or a Sony Mavica® camera. The images appear in a convenient light-table format, so that you can easily view the contents of an entire folder.

### **Quicken® 2002 New User Edition**

*Intuit Inc.*

Quicken software is a fast, easy way to organize your finances. Quicken software works just like your checkbook, so it's easy to learn and use. You can even pay your bills online. Quicken software manages all of your finances, bank accounts, credit cards, investments, and loans. (Users of earlier versions of Quicken software must upgrade for a fee.)

### **QuickTime®**

*Apple Computer, Inc.*

The versatile QuickTime software is used to play hundreds of different kinds of files, including video, audio, and virtual reality (VR) movies. You can play QuickTime files (referred to as "QuickTime movies") using QuickTime Player or any other application, such as a Web browser or word processor, that supports QuickTime software.

### **RealJukebox®**

*RealNetworks, Inc.*

RealJukebox software is a popular digital music system that gives you the ability to easily acquire, play and manage digital music files. You can locate and download your favorite music from the Internet and organize your own personal music collection.

 If you use an external CD-ROM drive connected with a PC Card, connect the external CD-ROM drive before starting RealJukebox. Do not remove the CD-ROM drive while using RealJukebox. Either action may cause RealJukebox to shut down improperly.

Sony recommends using the SonicStage software's Record function to create any CDs on your VAIO® computer, if the specific model you purchased is preconfigured with all necessary components for CD-R and CD-RW capability. Downloading the optional RealJukebox CD-burning component to create any CDs on your computer may interfere with normal system operations.

### **RealPlayer®**

*RealNetworks, Inc.*

RealPlayer software is a high-quality streaming media player that supports many digital media formats. The user-friendly interface has enhanced navigation capabilities, allowing you to access and enjoy audio and video programming over the Internet. RealPlayer software is your gateway to a superb Internet multimedia experience.

### **Smart Capture**

*Sony Electronics Inc.*

Smart Capture is a fun new way to send multimedia messages via e-mail. Smart Capture manages the i.LINK® connection between your computer and a Sony Digital Handycam® Camcorder that supports the i.LINK interface. It allows you to capture compressed video or still images and save them to your hard disk drive or share via e-mail. A smart solution for computer, digital audio/video and network convergence.

### **Smart Connect**

*Sony Electronics Inc.*

Smart Connect software enables you to use an i.LINK® cable to connect your VAIO® computer to another VAIO computer that supports Smart Connect. You can use one computer to copy, delete, and edit files on the other computer. You can also print from a printer attached to either computer.

### **SonicStage™**

*Sony Electronics Inc.*

This new jukebox application adds a host of new features to its predecessor, OpenMG™ Jukebox. Continuing to take advantage of Sony's copyright-protected ATRAC3™ format for high-quality digital audio storage, SonicStage software sports a new music visualizer, a sleek new player skin design, audio CD burning capability, and a parametric equalizer for fine-tuning audio playback.

### **Sony on Yahoo!**

*Yahoo! Inc.*

Personalize your own web portal with Sony on Yahoo! Get a free webmail account, customized news and local weather reports, comics, instant messaging, and more.

### **VAIO Support Agent**

*Sony Electronics Inc.*

VAIO Support Agent provides immediate, interactive, online support with information about your preinstalled software and answers to frequently asked questions.

### **VisualFlow™**

*Sony Electronics Inc.*

VisualFlow software is a state-of-the-art Sony multimedia browser designed specifically for Memory Stick® media. It displays any still picture, movie or sound file stored in a Memory Stick media in a visually pleasing, artistic manner. VisualFlow software not only plays a selected movie or sound file, but also enables playback of files by other applications like PictureGear™ or Memory Stick Slideshow.

### **WinDVD® 2000**

*InterVideo, Inc.*

WinDVD 2000 software is a simple-to-use DVD player that offers all the features you would expect to find in a standard consumer DVD player, including advanced display and navigation features such as zoom, pan, bookmark, and time search.

## **Software Support Information**

### **Adobe® Acrobat® Reader®, Photoshop® Elements, Premiere® LE (Adobe Systems Inc.)**

---

Web site	<a href="http://www.adobe.com/">http://www.adobe.com/</a>
e-mail	<a href="mailto:techdocs@adobe.com">techdocs@adobe.com</a>
telephone	206-675-6126 (fee-based support)
fax	206-628-5737
hours	M-F, 6 AM-5 PM (PST)

---

### **Apple QuickTime® (Apple Computer, Inc.)**

---

Web site	<a href="http://www.apple.com">http://www.apple.com</a>
telephone	800-275-2273
hours	M-F, 6 AM-6 PM (PST)

---

### **America Online® (America Online, Inc.)**

---

Web site	<a href="http://www.aol.com">http://www.aol.com</a>
telephone	800-827-3338
hours	7 days a week, 24 hours a day

---

### **Arcsoft PhotoPrinter® 2000 Pro (ArcSoft, Inc.)**

---

Web site	<a href="http://www.arcsoft.com">http://www.arcsoft.com</a>
e-mail	<a href="mailto:support@arcsoft.com">support@arcsoft.com</a>
telephone	510-440-9901
fax	510-440-1270
hours	M-F, 8:30 AM-5:30 PM (PST)

---

### **EarthLink™ Network Total Access (EarthLink Network Inc.)**

---

Web site	<a href="http://support.earthlink.net/">http://support.earthlink.net/</a>
e-mail	<a href="mailto:support@earthlink.net">support@earthlink.net</a>
telephone	800-890-5128, 800-890-6356
hours	7 days a week, 24 hours a day

---

**PC-Cillin® 2000 (Trend Micro, Inc.)**

Web site	<a href="http://www.antivirus.com/pc-cillin/support/">http://www.antivirus.com/pc-cillin/support/</a>
telephone	949-387-7800; 900-820-8324*
hours	M-F, 8 AM-5 PM (PST)

\* Support from 949-387-7800 is free of charge, but subject to delays. Support from 900-820-8324 is fee-based, but offers immediate response.

**Quicken® 2002 New User Edition (Intuit Inc.)**

Web site	<a href="http://www.intuit.com/support">http://www.intuit.com/support</a>
telephone	900-555-4932; 800-644-3193*
hours	M-F, 5 AM-5 PM (PST)

\* Support from 900-555-4932 is fee-based. Support from 800-644-3193 is automated and free of charge.

**RealJukebox®, RealPlayer® (RealNetworks, Inc.)**

Web site(s)	<a href="http://service.real.com/rjoptions.html">http://service.real.com/rjoptions.html</a>
e-mail	<a href="http://service.real.com/help/call.html">http://service.real.com/help/call.html</a> (online e-mail form)

**Sony Applications (Sony Electronics Inc.)**

Web site	<a href="http://www.sony.com/pcsupport">http://www.sony.com/pcsupport</a>
telephone	888-4-SONY-PC (888-476-6972)*
hours	7 days a week, 24 hours a day

\* Support from 1-888-4-SONY-PC is free of charge for 90 days after the original date of purchase.

**Windows® Operating System, Word, Office XP Professional, XP Small Business (Microsoft Corp.)**

Web site	<a href="http://www.sony.com/pcsupport">http://www.sony.com/pcsupport</a>
telephone	888-4SONYPC (888-476-6972)*
hours	7 days a week, 24 hours a day

\* Support from 1-888-4-SONY-PC is free of charge for 90 days after the original date of purchase.

**WinDVD® 2000 (InterVideo, Inc.)**

---

Web site	<a href="http://www.intervideo.com">http://www.intervideo.com</a>
telephone	510-651-0888

---



## ***Sony Service Center***

For the Sony Service Center nearest you, call 1-888-4-SONY-PC (1-888-476-6972) or find Sony Customer Service on the Web at <http://www.sony.com/pcsupport>.



# VAIO AV APPLICATIONS

*Your VAIO® computer is preconfigured with a collection of audio and video (AV) applications that make it easy to use advanced multimedia technology. This section describes the VAIO® AV applications.*

 Your computer may not be supplied with all of the software applications listed, depending on the system configuration you purchased.

Your computer's visual presentation of the VAIO AV applications may not appear exactly as shown in this section, depending on the specific computer model you purchased.

## **Overview of Preinstalled Software**

### **DigitalPrint**

*Sony Electronics Inc.*

DigitalPrint image management software makes it easy and fun to import, edit, and organize your digital pictures in a photo album for rich digital printing to any standard color laser or inkjet printer. DigitalPrint can also be used to make custom CD labels for your audio CDs.

### **DVgate™**

*Sony Electronics Inc.*

Connect a compatible digital video camera to your computer's i.LINK® port and capture video clips and still images. You can edit clips from your video, add new clips, and combine clips into new movie segments. You can also save your images in a variety of popular file formats.

### **MovieShaker™**

*Sony Electronics Inc.*

MovieShaker software creates personal movies that have transitions, background music, special effects, and text. Just import your video clips, and “shake” with a click of the mouse. Your personal movies are easy to create and fun to share with family and friends.

### **Smart Capture**

*Sony Electronics Inc.*

Smart Capture software is a fun new way to send multimedia messages via e-mail. It manages the i.LINK® connection between your computer and a Sony digital Handycam® camcorder that supports the i.LINK® interface. Smart Capture enables you to capture compressed video or still images and save them to your hard disk drive or share them via e-mail. A smart solution for computer, network, and digital audio and video convergence.

## **SonicStage™**

*Sony Electronics Inc.*

The SonicStage jukebox application gives you all the tools you need to manage music on your computer. SonicStage software sports high-quality digital audio storage, a music visualizer, a sleek player skin design, audio CD burning capability (on computer models that include a CD recording device), and a parametric equalizer for fine-tuning audio playback.

## **SonicStage™ Premium**

*Sony Electronics Inc.*

SonicStage Premium software is a special jukebox application that supports high-quality digital audio playback and recording from the Net MD™ player, FM Tuner, and DVD-RW devices in your VAIO® MX computer. Recording from external analog and digital audio devices, such as CD players and MiniDisc players, is also supported. SonicStage Premium software includes several standard jukebox features, including a music visualizer, audio CD burning capability, and a parametric equalizer for fine-tuning audio playback.

---

*Change text in this variable definition to document title.*

## DigitalPrint Software

DigitalPrint is designed to creatively manage your digital pictures. With its easy-to-use features, you can quickly load images from your digital camera or camcorder, print high-quality photos, and make personalized photo albums and labels to share with friends and family.

### DigitalPrint main window

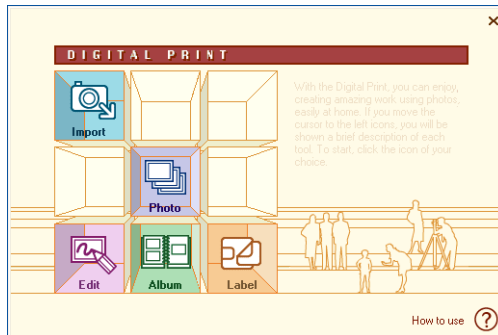

### Using PhotoCapture

Capture and import your digital pictures from your digital camera or camcorder into your computer. You can select your favorite pictures and place them in handy folders for future use.

- 1 Click the  (Import) icon to open the PhotoCapture window. Your connected digital camera, camcorder, or Memory Stick® media is indicated in the window.

 Properly connect your digital camera, camcorder, or insert your Memory Stick media in your computer.

---

Change text in this variable definition to document title.

### *PhotoCapture window*

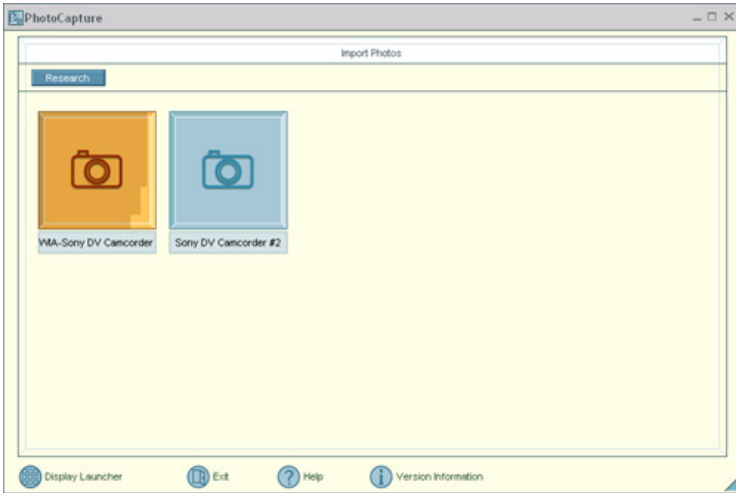

- 2 Click the camera icon to open the **Enter Photo Folder Name** dialog box. You can enter a name for a new folder or click **Select Photo Folder** to import your pictures to an existing folder. Click **OK**.

### *Enter Photo Folder Name dialog box*





- 3 Click **Capture** to capture still images. You can preview a thumbnail version of your pictures in the selection view window.

### *Capture Pictures from Video window*

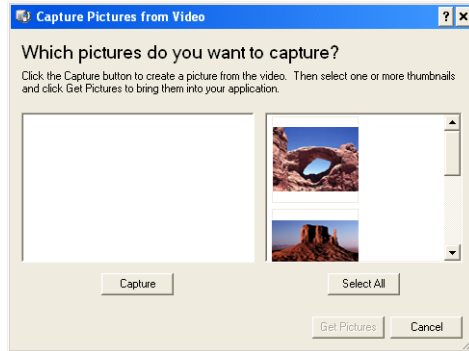

- 4 Select the desired pictures, and click **Get Pictures**. The PhotoCapture picture editor window appears.
- 5 Click **View** to see an enlarged version of a selected picture. You can click the  (Rotate) icons to change the position of a selected picture. Click **Delete** to eliminate any unwanted pictures.

---

Change text in this variable definition to document title.

### ***PhotoCapture editing window***

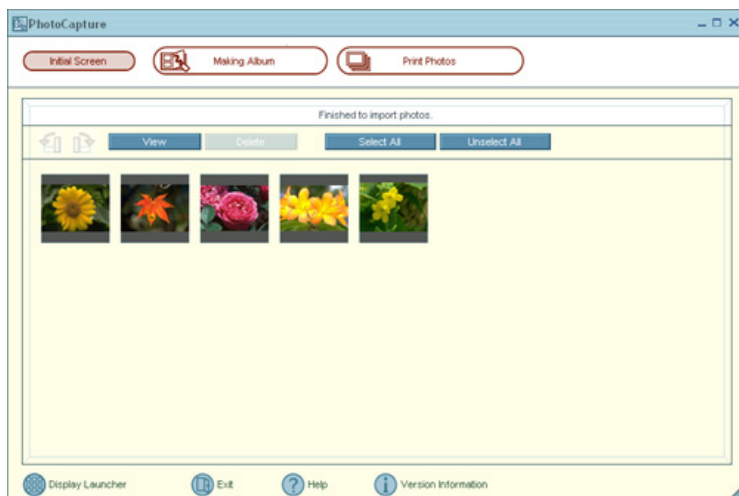

### ***Using PhotoCollection***

You can select and print your favorite digital pictures, using your computer and home printer.

- 1 Click the  (Photo) icon to open the **PhotoCollection** window. A list of folders is displayed on the left side of the window, with the folder contents displayed as thumbnail pictures on the right.

### *PhotoCollection window*



- 2 Select the desired folder. From the thumbnail view, click to select the pictures you want to print.
- 3 Click **Photo Print** at the top of the window. Use the scroll arrows to select the number of prints you want to make. Click **OK**.
- 4 Select the paper format based on the picture positioning desired. A layout preview is displayed on the left side of the window.
- 5 Use the configuration buttons and drop-down lists to select the printer and to set margins.

---

Change text in this variable definition to document title.

### ***Printer and Paper selection window***

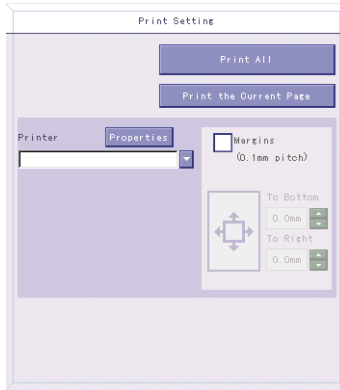

- 6 Click **Print All** to print all pages, or click **Print the selected page only** to print a specific page of photos.

### ***Using PhotoDecor***

You can decorate your favorite photos with clip art, stamps, or your own drawing talent. Add, remove, and change your designs to create your own unique photo art.

- 1 Click the  (Edit) icon to open the **PhotoDecor - New PhotoDecor** window. A list of folders is displayed on the left side of the window, with the folder contents displayed as thumbnail pictures on the right.

### *PhotoDecor-New PhotoDecor window*

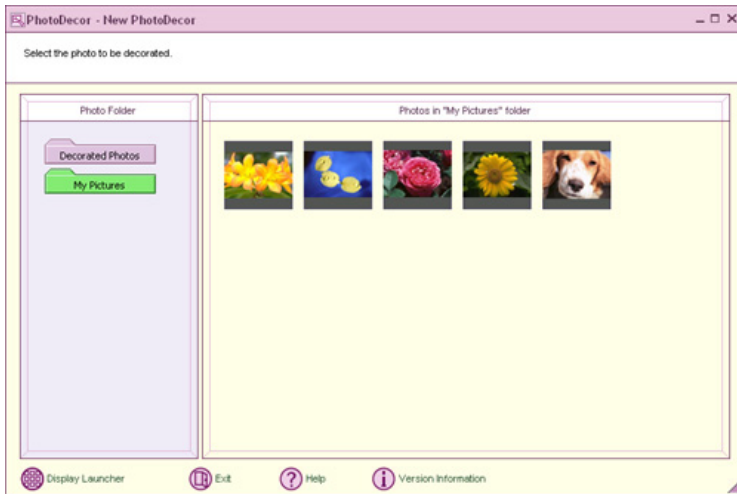

- 2 Select the desired folder. From the thumbnail view, click to select the pictures you want to decorate. The PhotoDecor editing window appears.
- 3 Use the decoration features on the right side of the window by clicking on the desired decoration icon and dragging the decoration onto your photo.
- 4 Click **Print** when your photo is ready to be printed. You can save your decorated pictures before printing. Name the new picture, and click **Save**.

 The default location for your saved decorated pictures is in the **Decorated Photos** folder, which can be viewed from the **PhotoDecor - New PhotoDecor** window.

### *Using PhotoAlbum*

Capture your special photos in an organized photo album. You can share your custom-made photo albums with friends and family.

---

Change text in this variable definition to document title.

- 1 Click the  (Album) icon to open the **PhotoAlbum - New Album** window.

### *PhotoAlbum - New Album window*

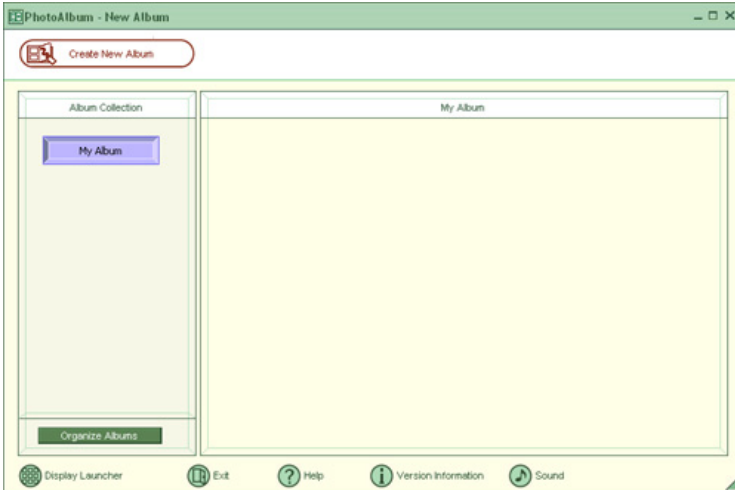

 If you want to work on a previously created album, do not click **Create New Album**. Instead, select the desired album from the **Album Collection** view on the right side of the window.

- 2 Click **Create New Album**. The **Select Photo** window appears.
- 3 Select the photos you want to include in your album from the available folders displayed. Click **List** to select individual pictures from each folder. The **Select Design** window appears.
- 4 Select a design template for your album. Use the scroll bar to see all available designs. When you have selected a design, the **Select Layout** window appears.
- 5 Select a page layout for your album. A preview of your selected design and page layout is displayed. Scroll through the album using the book icons at the bottom of the window.

- 6 Click **Page List** to edit your album. Customize your album by adding more pictures, decorations, or comments, or by deleting pages.
- 7 You can save your album before printing by clicking **Save**.
- 8 Click **Print**. Select an album type, and click **Print** again.

 For information on stitching your album, click **Stitch Album**. See the online Help file for more details.

## Using LabelMaker

Use LabelMaker to design original labels to personalize your media, such as Memory Stick® media, CDs, or video cassettes.

- 1 Click the  (Label) icon to open the **Label - New Label** window.

### Label - New Label window

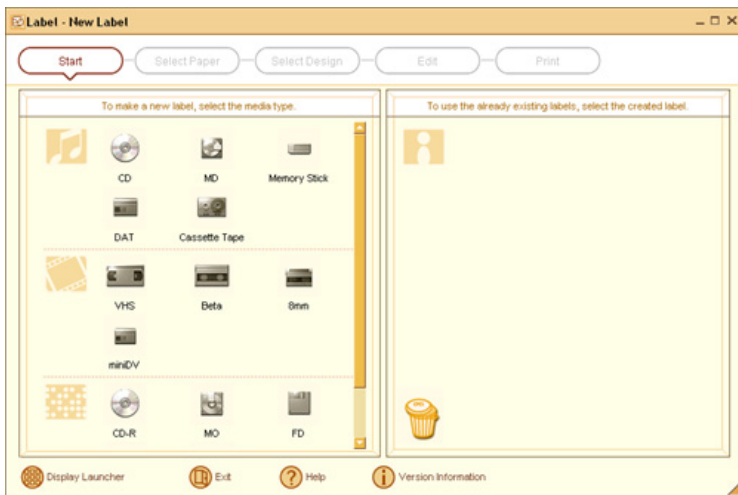

- 2 Click an icon to select a media type. A new window opens.
- 3 Click the paper layout icon. The **Select Design** window appears.
- 4 Select a design template. Use the decoration and customization features on the right by clicking an icon and dragging it onto your template.

---

Change text in this variable definition to document title.

 A new window appears, enabling you to list the contents of your audio or video media. You can create a song or video list, depending on the type of media label being created.

### *Design Edit window*

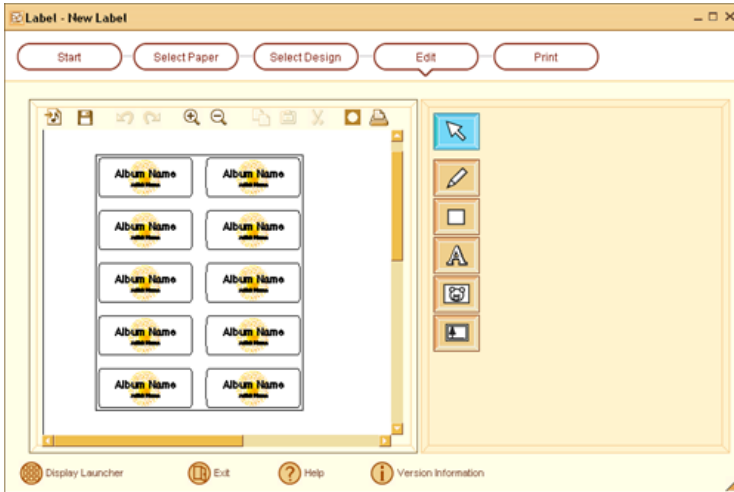

- 5 Click **Print** to complete the label-making process. Use the configuration buttons and drop-down lists to select the printer and to set margins.

 See the online Help for detailed information on using DigitalPrint software.



## DVgate Software

 For detailed information about using DVgate™ software, refer to the online Help within the DVgate software.

### **Connecting a digital video camcorder**

Turn off the power to your digital video camcorder before connecting it to your computer. After connecting the device, turn its power back on. You do not need to turn off the computer when connecting the camcorder.

DVgate software does not support MICROMV™ digital video cameras.

### **To use DVgate™ software with a digital video camcorder**

- ❑ Under the Microsoft® Windows® XP operating system, do not capture DV-AVI video files to the root directory (the top level) of your hard disk drive. Instead, create a folder and capture files to this folder.
- ❑ Do not use DVgate™ software when the connected digital video device is in Timer Recording mode, as this may produce a malfunction in the device.
- ❑ Video captures larger than 2 GB (9 minutes and 30 seconds) are automatically continued in a second file.
- ❑ You can record stereo audio (stereo 1) while capturing video, or you can add audio on the stereo 2 track after capturing the video data.
- ❑ You cannot use different audio modes on the same tape. Perform a separate capture for each audio mode you wish to use.
- ❑ DVgate software does not support hard disk compression. Do not use disk compression if you are planning to work with DVgate software.
- ❑ Title data is saved in the flash memory of a digital video camera and is not transferred to tape by DVgate software.
- ❑ Disable your screen saver program to avoid interruption during your capture sessions.
- ❑ The drop frame compensation feature does not provide accurate compensation adjustments for tapes recorded in LP mode.
- ❑ The information displayed by the capture progress indicator may not be accurate for tapes that are recorded using a mixture of both SP and LP modes.

---

*Change text in this variable definition to document title.*

- ❑ Keep the video head of your digital video device properly cleaned. Anomalies that you see in captured data may be due to dust or other particles on the video head.
- ❑ The last frame captured is one frame before your selected [OUT] point. The frame you see immediately after clicking the [OUT] button is not captured.

### ***To use DVgate software to record AVI files to tape***

 You can record only AVI files. MPEG files cannot be recorded.

- ❑ Do not use DVgate™ software when the connected digital video device is in Timer Recording mode, as this could produce a malfunction in the device.
- ❑ Avoid recording problems, such as a single frame appearing in multiple frames, by closing other applications on your system while recording.
- ❑ You cannot use multiple audio modes on the same tape. If you have AVI files that use different audio modes, the files cannot be recorded at the same time, but must be recorded separately.
- ❑ The DVgate software does not support AVI files that are smaller than 4 MB.
- ❑ The DVgate software does not support hard disk compression.
- ❑ To maximize recording capabilities, video and audio data are not available while you are recording.
- ❑ If the DVgate software indicates that frames are dropped, try closing all open applications or defragmenting your hard drive.

## MovieShaker Software

MovieShaker™ software can be used to create fun and innovative movies without any previous knowledge of film editing. In a few simple steps, you can turn a collection of video clips, still images, and audio files into a finished movie with special effects and music. You can save your personal video creation in a format that is compatible with most computers or save it to a tape in your compatible digital video (DV) or MICROMV™<sup>1</sup> video camera.

### MovieShaker software main window

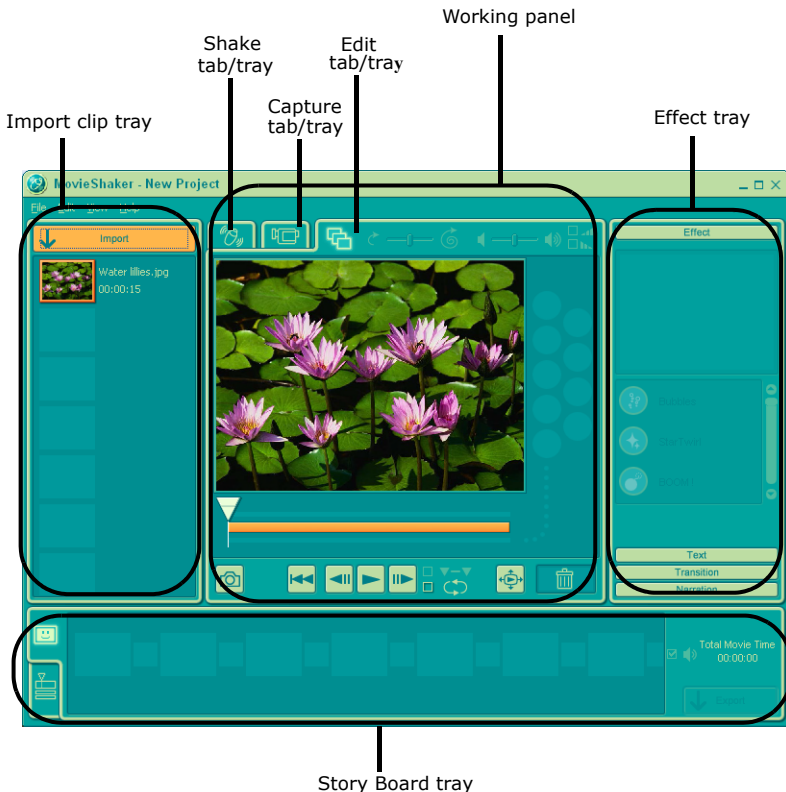

<sup>1</sup> MICROMV cameras are not supported on C1-series notebook models.

## ***Creating movies with MovieShaker software***

Using your imported clips, you can create a short movie using the Shake feature. The Shake feature selects clips from the Story Board tray, adds effects, and combines them randomly into a 30-second movie. After you “Shake” your video, you can edit it by adding effects and text, by adjusting the color and contrast, and by modifying its length.

### ***Importing images and sound clips***

- 1 Click . The **Import** file browser window appears.
- 2 Find the clips you want to add.
- 3 Click the clips. The files are added to the **Import** clip tray.
- 4 Repeat this process to gather each of the images and video and sound clips you want to use in your movie.

 You can delete a clip from the Import clip tray by dragging the clip’s icon to the trash icon located on the **Edit** tray of the working panel.



**Importing image or sound files that are over 30 seconds in length may cause the MovieShaker software to stop responding.**

### ***Using the Shake feature***

- 1 Click the **Shake** tab. The **Shake** tray appears
- 2 Select a mood by clicking a face in the **Shake** pattern tray.

## Shake tray



- 3 Click the **Shake!** button. A 30-second movie is automatically generated.
- 4 **Optional:** Add text to your new movie by clicking on the **Input** button.
- 5 To preview, rewind, or fast forward your movie, use the **Playback** buttons.

 Scenes created with the Shake feature begin with a black screen in the Shake tray window. Your scenes appear during movie playback.

You can improve the image quality produced by the Shake feature (at the cost of longer Shake times) by turning off the “Shorten the Shake time” feature in the General panel of the **Setting** dialog box. See the **Menu reference** section of the online Help file for details.

## Adding effects to a scene or a clip

- 1 Double-click or drag the desired clip or scene to move it to the **Story Board** tray.
- 2 Click the **Effect** button on the **Effect** tray.

---

Change text in this variable definition to document title.

### **Effect tray window (Effect button selected)**

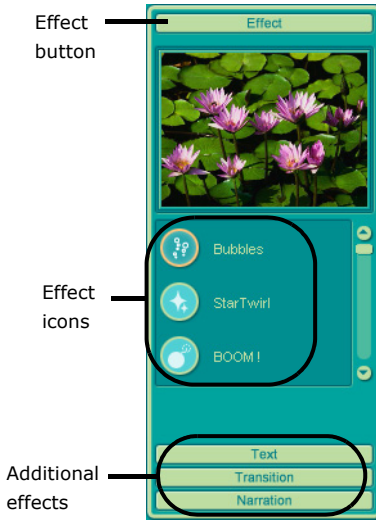

- 3 Drag the Effect icon you want to add from the **Effect** tray to the **Effect** palette on the **Edit** tray.
- 4 Click the **Play** button on the **Edit** tray to preview the effect. The added effect previews on the clip displayed in the **Effect** tray window.

 A preview of the added effect is displayed in the **Effect** tray window. You can eliminate an effect by dragging it from the **Effect** palette to the trash icon on the **Edit** tray. See the online Help file for more information on adjusting effect duration and replaying clips and scenes.

### **Adding text effects to a scene or clip**

- 1 Double-click or drag the clip or scene to move it to the **Story Board** tray.
- 2 Click **Text** on the **Editing** tray.

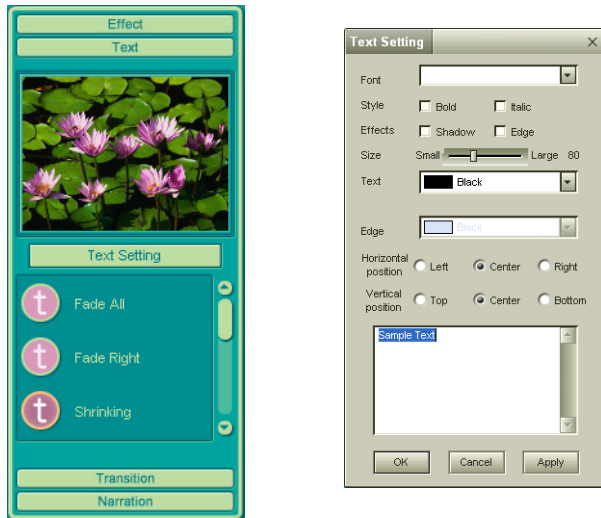
**Effects Tray (Text button selected)**

- 3 Click **Text Setting** to create customized text. The **Text Setting** dialog box appears. Enter your text, and select the font, size, color, and positioning for your text.
- 4 Drag the Text effect icon you want to add from the **Effect** tray to the **Effect** palette on the **Edit** tray.
- 5 Click the **Play** button on the **Edit** tray to preview the text effect. The clip displays the text effect in the **Effect** tray window.

 A preview of the added text and text effect is displayed in the **Effects** tray window. From the **Edit** tray, you can eliminate a text effect by dragging it from the **Effect** palette to the trash icon. See the online Help file for more information on adjusting Text effects.

**Saving a movie**

- 1 Verify that the movie or clips you want to save are located on the **Story Board** tray.
- 2 Click **Export** on the **Story Board** tray.

---

Change text in this variable definition to document title.

- 3 Select the format in which you want the movie to be saved.

 You can click on each export format to view its description and use.

### ***Export window***

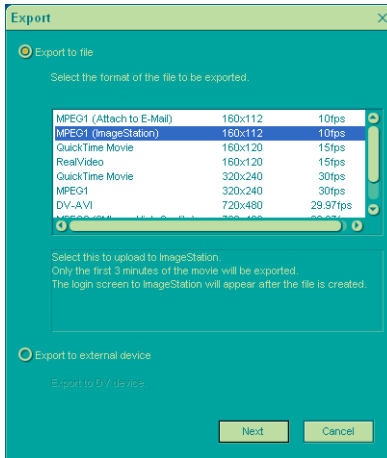

- 4 Click **Next**.
- 5 Confirm that you want to continue.
- 6 Locate the folder to which you want to save the file, name your file, and click **Save**.

 The time required to export your movie file will vary with the format selected. See the online Help file for more information on exporting a movie.

### ***Using the ImageStation online service with MovieShaker software***

ImageStation<sup>SM</sup> is an online service that allows you to store your pictures and movies on the Internet to share with family and friends. The ImageStation service requires an Internet connection and registration for the Web-based service. You must be connected to the Internet before uploading your pictures or movies using the MovieShaker software and ImageStation applications.



### To upload MovieShaker files

- 1 Locate the clips or video files that you want to upload to the ImageStation service, and import them to the **Import Clip** tray.
- 2 Drag the desired clips or video files to the **Story Board** tray.
- 3 Click the **Export** button. The **Export** window appears.
- 4 Select **MPEG1 (ImageStation)**, and click **Next**.

 The MovieShaker application creates a temporary file to store your images prior to uploading to the ImageStation service. This file is deleted after the upload process.

- 5 If you are a registered member, provide your login name and password.  
For first-time users, click **Register to ImageStation**. The ImageStation service registration wizard appears and guides you through the initial registration process. Follow the on-screen instructions.

### ImageStation Login window

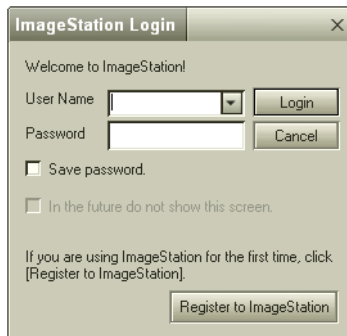

ImageStation Login

Welcome to ImageStation!

User Name  Login

Password  Cancel

Save password.

In the future do not show this screen.

If you are using ImageStation for the first time, click [Register to ImageStation].

Register to ImageStation

- 6 When the ImageStation application on your computer connects with ImageStation online, your files are uploaded to the Web site. The **Image Uploader** window appears and displays the Internet connection and upload status.

---

Change text in this variable definition to document title.

### ***Image Uploader window***

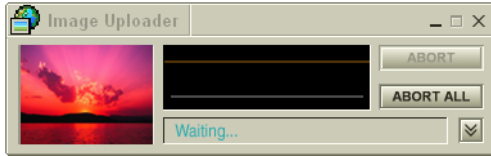

- 7 Go to <http://www.imagestation.com> to view your uploaded pictures or movies. Follow the on-screen instructions to access your ImageStation account.

 The ImageStation Web site may ask you to complete a full login again if your current session is not active.

## Smart Capture Software

Smart Capture manages the i.LINK® connection between your computer and a i.LINK compatible digital camera or camcorder. You can capture and enhance video or still images to share with your family and friends over the Internet or through e-mail.

 i.LINK is a trademark of Sony used only to designate that a product contains an IEEE1394 connection. The i.LINK connection may vary, depending on the software applications, operating system and compatible i.LINK devices. All products with an i.LINK connection may not communicate with each other.

Please refer to the documentation that came with your compatible i.LINK device for information on operating conditions and proper connection. Before connecting i.LINK compatible PC peripherals to your system, such as an optical disc drive or hard disk drive, confirm their operating system compatibility and required operating conditions.

### Smart Capture main window

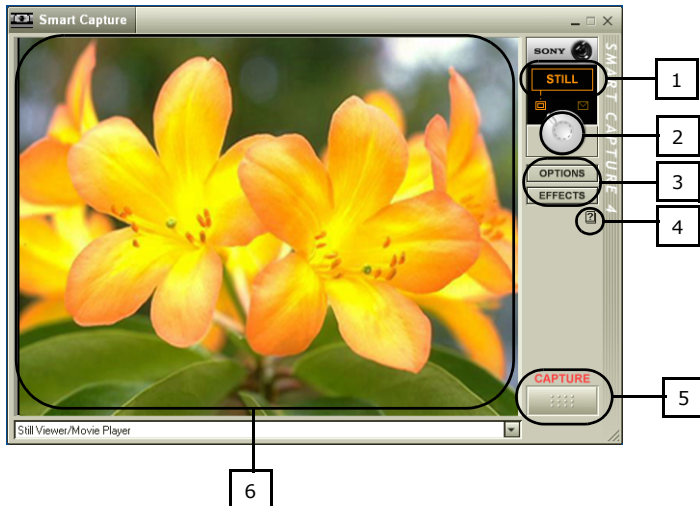

#### 1 Mode indicator

Displays the current mode (**Still** or **Net Movie**).

#### 4 Help button

Connects you directly to the online Smart Capture Help.

- |   |   |
|---|---|
| <p><b>2 Mode dial</b><br/>Switches Smart Capture from <b>Still</b> mode to <b>Net Movie</b> mode with a single click of your mouse.</p>   | <p><b>5 Capture button</b><br/>Captures your individual still images in the same manner as a camera. You can select different characteristics for the <b>Capture</b> button when capturing a Net Movie.</p> |
| <p><b>3 Options button</b><br/>Displays the configuration options available for either <b>Still</b> or <b>Net Movie</b> mode.</p> <p><b>Effects button</b><br/>Displays the special effects that you can apply to your pictures or video clips.</p> | <p><b>6 Image window</b><br/>Displays the still or video image from your digital camera or camcorder.</p>   |
- 

The **Smart Capture** main window opens with a blue screen image, indicating that there is no data input from a digital camera or camcorder. When you connect your digital camera or camcorder to your system with an i.LINK® cable and turn it on, an image appears in the main window. Some cameras and camcorders need to have recording media inserted before an image can be displayed in the **Smart Capture** window. Consult the manual supplied with your digital camera or camcorder for more information.

### ***Using Still Mode***

- 1 Click **Start** in the Windows® taskbar, and click **All Programs**.
- 2 Point to **Smart Capture**, and click **Smart Capture**. The **Smart Capture** main window appears.
- 3 Connect your i.LINK compatible digital camera or camcorder to your computer with an i.LINK cable (optional). An image appears in the **Smart Capture** main window.
- 4 Check that the **Mode** dial is set to **Still**. Click the **Mode** dial to switch between **Still** mode and **Net Movie** mode.
- 5 Click **Options** to view the available options for your still image capture. The **Still Image Options** window appears.

### Still Image Options window

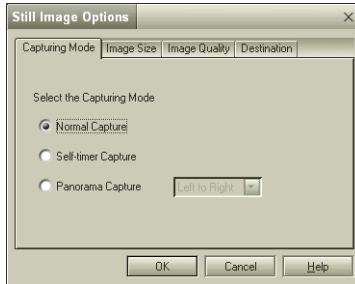

The Still Image Options window has four tabs:

- Capturing Mode** — You can choose between **Normal**, **Self-timer**, or **Panorama** Capture modes.
  - Image Size** — Select the image size, horizontal by vertical, in pixels.
  - Image Quality** — Set the quality of your captured pictures by selecting **Fine**, **Standard**, or **Economy** image quality.
  - Destination** — Select a file destination for your pictures.
- 6 Click **Effects** to select a special image effect. The **Effect Settings** window appears. Use the drop-down list to view and customize the available effects.

### Effect Settings window

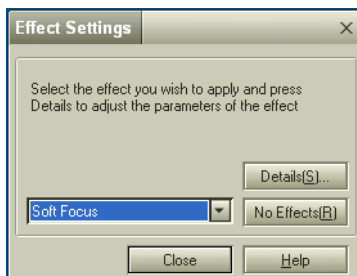

 You can use a different special effect for each picture, or you can remove all special effects by clicking **No Effects**.

---

Change text in this variable definition to document title.

### ***To capture a picture in Still mode***

- 1 Use your digital camera or camcorder to locate the image you want to capture. When you see the desired image in the **Smart Capture** window, click **Capture**. The **Still Viewer** window appears. You can capture a single picture or several pictures at once.

### ***Still Viewer window***



- 2 Click the arrows or drag the scroll bar to view the pictures. As each image is captured, it appears in the **Still Viewer** window with a text balloon to add your comments and an identifying number in the viewer queue.

### ***To manage pictures in Still mode***

In the **Still Viewer** window, you can perform various functions using the task buttons:

- ❑ **Delete** — Discard any or all of your still images by clicking **Delete**. Select a single image or all and the image(s) are removed from the **Still Viewer** window.
- ❑ **Upload** — Send your still images online to the ImageStation Web site to share with your family and friends. The ImageStation service stores your still images online when you become a registered user. See “Using the ImageStation online service with Smart Capture software.”
- ❑ **Mail** — E-mail your still images to your family and friends. Click **Mail**, and your e-mail application launches with a new message window containing the still image as an attachment.
- ❑ **Save** — Click **Save** to save your still image to a location of your choice in any of a variety of formats

 You must be connected to the Internet before attempting to upload or e-mail your still images or videos.

## Using Net Movie Mode

- 1 Click **Start** in the Windows taskbar, click **All Programs**, point to **Smart Capture**, and click **Smart Capture**. The **Smart Capture** main window appears.
- 2 Connect your i.LINK compatible digital camcorder to your computer with an i.LINK® cable (optional). An image appears in the **Smart Capture** main window.
- 3 Verify that the **Mode** dial is set to **Net Movie**. Click the **Mode** dial to switch between **Still** mode and **Net Movie** mode.
- 4 Click **Options** to view the available options for your movie capture. The **Recording Options** window appears.

## Recording Options window

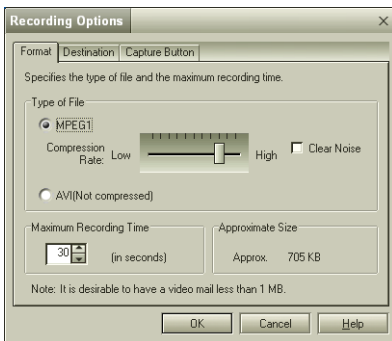

Format tab view

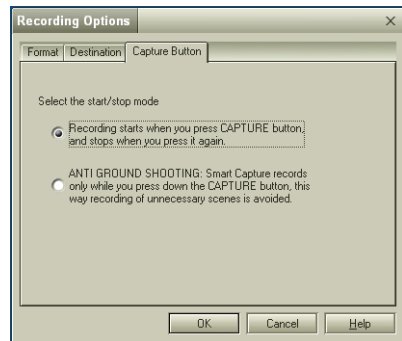

Capture Button tab view

The **Recording Options** window has three tabs:

- ❑ **Format** — You can adjust the compression rate for your movies in MPEG1 format or choose the AVI option for no compression. You can also set the maximum recording time for your movie capture.

---

Change text in this variable definition to document title.

- ❑ **Destination** — Select a file destination for your movies when recording video clips.
  - ❑ **Capture Button** — Set the characteristics of the software’s on-screen **Capture** button. You can start and stop recording by clicking **Capture** (this is the default characteristic). You can select **Anti-Ground Shooting**, which allows recording to occur only while you click and hold the Capture button. Recording will stop when you release the button.
- 5 Click **Effects** to select a special image effect. The **Effect Settings** window appears. Use the drop-down list to view and customize the available effects.

 You can remove all special effects by clicking the No Effects button.

### ***To capture a movie in Net Movie mode***

- 1 Use your digital camcorder to locate the view(s) you want to capture. When you see the desired view in either the **Smart Capture** window or your camcorder’s viewfinder, click **Capture** to begin recording your movie. The **Movie Player** window appears.
- 2 Click **Capture** when you have finished recording your movie. The first frame of your movie appears in the **Movie Player** window. You can record a movie for approximately 30 seconds. The Movie Player feature automatically stops recording when this time limit is reached.

 If you have set the **Capture** button to use the **Anti-Ground** setting, you must click and hold the **Capture** button to record your movie.



### *Movie Player window*



- 3 You can review your movie from the **Movie Player** window by using the play/pause and stop buttons. Click the arrows or drag the scroll bar to view your movie. Each frame is displayed with an identifying number in the queue.

### *To manage your movie in Net Movie mode*

From the **Movie Player** window you can perform various functions using the task buttons:

- ❑ **Delete** — Discard any frame or the entire movie by clicking **Delete**. The frame or movie is removed from the **Movie Player** window.
- ❑ **Upload** — Send your movies online to the ImageStation Web site to share with your family and friends. The ImageStationSM service stores your movies online when you become a registered user. See “Using the ImageStation online service with Smart Capture software.”
- ❑ **Mail** — E-mail your movies to family and friends. Click **Mail**, and your e-mail application launches with a new message window containing the movie as an attachment.
- ❑ **Save** — Click **Save** to compress and save your movie to a location of your choice in any of a variety of formats.

## ***Using the ImageStation online service with Smart Capture software***

ImageStation<sup>SM</sup> is an online service that allows you to store your pictures and movies on the Internet to share with family and friends. The ImageStation service requires an Internet connection and registration for the Web-based service. You must be connected to the Internet before uploading your pictures or movies with Smart Capture and ImageStation applications.

### ***To upload with Movie Player***

- 1 Click **UPLOAD** in the **Movie Player** window to begin transfer of your movie to the ImageStation Web site. The **Image Uploader** window appears and displays the Internet connection and upload status.

### ***Image Uploader window***

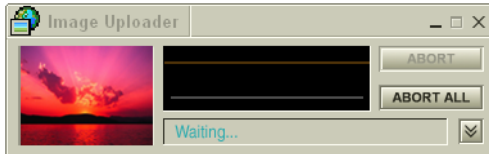

- 2 Click  to see thumbnail previews of your pictures or movies.

 The ImageStation preview feature is available when you upload two or more pictures or a movie. No preview is shown if a single picture is being uploaded.

## To upload with Still Viewer

- 1 Click **UPLOAD** in the **Still Viewer** window. The **ImageStation Login** window appears.

### ImageStation Login window

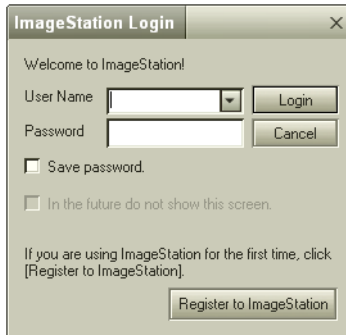

- 2 For first-time users, the ImageStation<sup>SM</sup> registration wizard guides you through the initial registration process. Follow the on-screen instructions. If you are already a registered member, provide your login name and password. The **Image Uploader** window appears.
- 3 From the **Still Viewer** window, click **UPLOAD** to transfer your pictures or movies to the ImageStation Web site. The **Image Uploader** window displays your Internet connection and upload status. Click  to see thumbnail previews of your pictures or movies.

 The ImageStation preview feature is available when you upload two or more pictures or a movie. No preview is shown if a single picture is being uploaded.

- 4 Go to <http://www.imagestation.com> to view your uploaded pictures or movies. Follow the on-screen instructions to access your ImageStation account. The ImageStation Web site may ask you to complete a full login again, if your current session is not active.

 It is recommended that your movie file size not exceed 254 MB if compressed or 2 GB if not compressed. Large movie files take longer to upload to the ImageStation Web site.

---

*Change text in this variable definition to document title.*

## SonicStage Software

SonicStage™ software  is a new jukebox application that enables you to play and record from audio CDs and import digital audio files while maintaining copyright information. Taking advantage of Sony's copyright-protected ATRAC3™ format for high-quality digital audio storage, SonicStage sports a music visualizer, a sleek player skin design, audio CD burning capability, and a parametric equalizer for fine-tuning audio playback.

### **Electronic Music Distribution (EMD) Services**





EMD enables you to download music files via the Internet. To use Internet services that are compatible with the SonicStage software, you need:

- Access to the Internet from your computer. Sign up with an Internet Service Provider (ISP) and configure your computer for Internet access before using EMD services.
- An EMD service provider. Consult the provider for service information.

### **Starting SonicStage Software**

- 1 Click **Start** in the Windows taskbar, and click **All Programs**.
- 2 Point to **SonicStage**, and click **SonicStage**.
- 3 When you have registered with CDDDB, the **Confirm the setup of SonicStage...** dialog box appears.
- 4 Click **Yes** to continue.

### **SonicStage feature tabs (Main window)**

- CD tab**  — The contents of your inserted audio CD are displayed, enabling functions such as recording to the computer's hard disk drive.
- Import tab**  — Import MP3, WAV or audio files on your computer to a Playlist.
- Playlist tab**  — View the available Playlists as **tree + list** or **list** only.
- Transfer tab**  — View the available Playlists on your computer. You can transfer the audio files to an external device or media.
- Device/Media tab**  — View the status of your audio files, connected external device, or inserted media.

---

Change text in this variable definition to document title.

- ❑ **Internet tab**  — The browser view displays your connection to the Internet, enabling you to locate audio files and use EMD services.

## SonicStage main window

### Playlist view

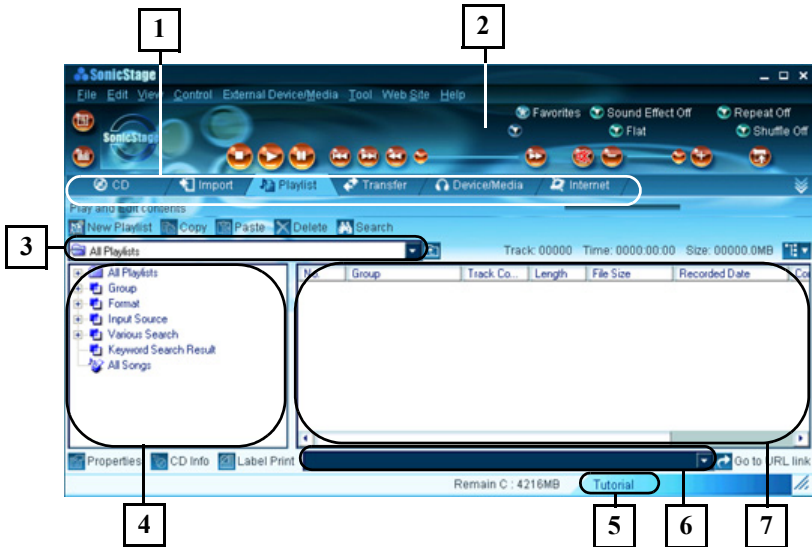

- 
- |  |  |
|--|--|
| <p><b>1 Feature tabs</b><br/>Changes the screen view according to the selected feature.</p>  | <p><b>5 Tutorial</b><br/>Click to open or close the Tutorial feature.</p>  |
| <p><b>2 Player control buttons</b><br/>Controls playback functions, such as play, pause, stop, fast forward, and reverse. You can increase or decrease volume and switch view modes.</p> | <p><b>6 Internet address drop-down list (Playlist view)</b><br/>Displays Internet addresses associated with the currently selected song. Click <b>Go to URL link</b> to immediately connect to the Internet address displayed in the drop-down list.</p> |
-

- 
- |   |  |
|---|--|
| <p><b>3 Playlist drop-down list (Playlist view)</b><br/>Displays available playlists and audio files.</p> | <p><b>7 File list view (Playlist view)</b><br/>Displays the contents of the Playlist selected in the file tree view.</p> |
|---|--|
- 
- 4 File tree view (Playlist view)**  
Displays the Playlists available on your computer, enabling you to locate your audio files. Expand the views for the file list or Playlist drop-down using the Playlist switch  button.
- 

### ***Recording from a CD***

You can record songs from audio CDs and add them to playlists in SonicStage software.

 When you record from an audio CD from your optical disc drive for the first time, the **CD Drive Optimization** dialog box appears. Click **Start** to verify your optical disc drive. After the verification is performed, recording begins.

- 1** Insert an audio CD into your computer's optical disc drive.
- 2** Click the **CD** tab.
- 3** Use the drop-down lists to select the ATRAC3 bit rate, CD drive, and Record To destination.

Change text in this variable definition to document title.

## CD tab window



- You can identify specific tracks on your CD by clearing the check marks from the tracks you don't want to record. You can clear all selected tracks by selecting the empty checkbox next to **Select All**, and then selecting the tracks you want to record.

If your Internet connection is active, you can use the  (CD Info) button to view the name of your CD and its song titles.

 The CDDB® (Compact Disc Database) Music Recognition Service registration wizard enables you to register with CDDB. You need Internet access from your computer to register and use this service. For more information regarding CDDB registration, click the **Help** button.

 The CD Info button feature is not supported for all audio CDs.

- Click  (Rec to Jukebox) to begin recording. When the recording is finished, the new playlist appears in the File tree view of the **Playlist** window.



## Transferring songs (Check-In/Check-Out)

You can transfer songs between the playlists in the SonicStage software and external devices or media. For more information on using your external devices or media, see the instructions supplied with the device or media.

These instructions are for using the Check-In/Check-Out “1-step” method. For information on using another method, see “Changing the check-in/check-out settings” in the SonicStage software online Help file.

### Check-Out

- 1 Connect the external device or insert the media into your computer.
- 2 Click the **Transfer** tab to display the **Transfer** window. Your computer automatically recognizes the connected external device or media and lists the content information in a new panel on the right side of the **Transfer** window.

### Transfer window

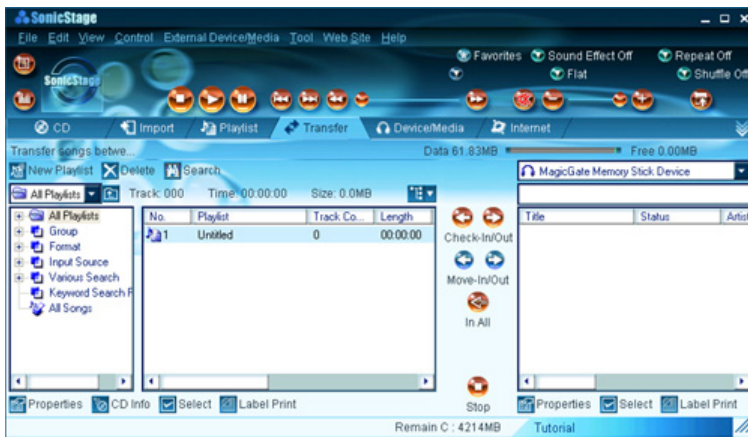



- 3 Select the Playlist that contains the song that you want to check out. The songs in the playlist are shown in the **Playlist** view panel located in the center of the **Transfer** window.

---



Change text in this variable definition to document title.



- 4 From the **Playlist** view panel, select the song to be checked out. To check out more than one song at a time, hold down the Ctrl key and select the additional songs.
- 5 Click  (Out), or drag the song to the desired position in the song list of the external device or media. Check Out begins.

 To cancel Check Out, click  (Stop), or click **Cancel** in the **Processing** dialog box that is displayed during the Check Out process.

### **Check In**

 The songs that you transfer to external devices or media can only be checked in to the hard drive of the same computer from which the songs were checked out.

- 1 Connect the external device or insert the media into your computer.
- 2 Click the **Transfer** tab to display the **Transfer** window. Your computer automatically recognizes the connected external device or media and lists the content information in a new panel on the right side of the **Transfer** window.
- 3 Select the song to be checked in from the song list of the external device or media. To check in more than one song at a time, hold down the Ctrl key and click the additional songs.
- 4 Click  (In), or drag the song(s) to the **Playlist** view panel. If you want to check in all of the songs in the external device or media, click  (In All). Check In begins.

 To cancel Check In, click  (Stop), or click **Cancel** in the **Processing** dialog box that is displayed during the Check In process.

For more information about using SonicStage software, go to the online SonicStage Help. You can access the online help file as follows:

- 1 Click the **Start** button in the Windows taskbar, and click **All Programs**.
- 2 Point to **SonicStage**, and click **SonicStage Help**.

## **Additional features**

- ❑ **SonicStage Tutorial** — SonicStage features are described in the Tutorial. The user-friendly interface instructs you on how to use all SonicStage features.
- ❑ **SonicStage Backup Tool** — You can back up and restore music, graphics, and information data managed by SonicStage software. You must be connected to the Internet to use the SonicStage Backup Tool.
- ❑ **Import audio files in various formats** — You can import audio files in various formats, such as the MP3 or WAV standards. You can also import audio files that comply with the Microsoft® Windows Media™ Technologies (WMT) standard, identified by .asf or .wma extensions. Manage your audio files through the Playlist feature of SonicStage software.
- ❑ **Manage imported songs on the Playlist** — Additional features are available when you register your imported songs through the Playlist feature of the SonicStage software. You can manage your music by creating your own list of songs categorized by genre or artist, displaying your song list in the Playlist feature, and arranging your songs in a customized order using the Playlist folders. Edit your music by combining multiple songs into a single song, or divide one song into two, by using the Combine and Divide features.
- ❑ **Simple mode** — The main SonicStage window viewed in Simple mode, is a smaller, compact version of Full mode. This may be convenient when you want to listen to music with SonicStage software, while using other applications, or whenever you feel the Full mode view is intrusive. The design of the main SonicStage window in simple mode can be changed by selecting a new “Skin,” which enhances the window’s appearance. The Simple mode feature enables you to perform playback operations only.

---

*Change text in this variable definition to document title.*

## **SonicStage Premium Software**

SonicStage™ Premium software\* is a unique integrated software application that supports high quality digital audio playback and recording using the MiniDisc drive, FM tuner, or DVD-RW drive of your VAIO® MX computer. You can easily record your favorite music from external analog and digital audio devices, such as a CD player. SonicStage Premium software has several jukebox features, including a Music Visualizer, audio CD-burning capability, and an equalizer for fine-tuning your audio playback.

 SonicStage™ Premium software is available only on VAIO® MX computer models.

### **Overview of SonicStage Premium Software**

SonicStage Premium software has unique features that integrate with your MiniDisc drive, FM tuner, and DVD-RW drive. The features expand the compatibility of the built-in audio devices, enabling you to create your own music database  (M drive) and share audio files using other audio media and devices.

SonicStage Premium software enables you to play and record audio CDs and import digital audio files while maintaining the copyright information of the contents.

When you record an audio CD, it is encoded in ATRAC3 format onto your computer's hard disk drive. You can also download (import) digital audio files from Electronic Music Distribution (EMD) services. The imported data can be played on your computer or transferred to external portable audio devices or media. SonicStage Premium software converts your existing MP3 and WAV format audio files into ATRAC3 format.

 You have the option of formatting your audio files in ATRAC3, MP3, or WAV formats. See the SonicStage Premium Help file for more information.

### **SonicStage Premium software features**

The software features enable you to:

---

\* Your VAIO® MX computer has SonicStage™ Premium software preinstalled. Some manuals or online help files may provide information about SonicStage™ software, which is a lighter version with fewer features. Follow the information provided in this guide or in the SonicStage Premium online Help file, to learn how to use SonicStage Premium software.

---

*Change text in this variable definition to document title.*

- ❑ Listen to music from different audio sources, such as FM radio stations, audio CDs, MP3 CDs, or an Electronic Music Distribution (EMD) service.
- ❑ Import your songs from various audio sources and create your own music database.
- ❑ Manage information about your audio files, such as the artist name, song title, and media jacket image, by grouping them into Playlists.
- ❑ Use search criteria to locate specific songs in your music database.
- ❑ Create custom CDs by selecting songs from different audio CDs or transferring songs from your music database.
- ❑ Transfer the imported songs in your music database to a MiniDisc, MagicGate™ Memory Stick® media, or other external device or media.
- ❑ Use SonicStage Premium software's sound effects, equalizer, or visualizer, to enhance your listening experience.
- ❑ Set up timed events using Timer Playback, Timer Recording, and Sleep Timer.

For more information about SonicStage Premium software features, follow these steps to access the SonicStage Premium Help file:

- 1 Click **Start** in the Windows® taskbar, and click **All Programs**.
- 2 Click **SonicStage Premium**, and click **SonicStage Premium Help**.

### ***SonicStage Premium software compatibility***

The software is compatible with several media, devices, and types of audio files. You can play back, listen to, and record, with the following:

#### ***Media***

- ❑ **Audio CDs (Including CD Extra and CD Text)** — You can play back, record to the hard disk drive, and make backup CDs.
- ❑ **MiniDiscs** — You can play back MiniDiscs that are recorded in LP stereo, stereo and mono recording modes. The M drive enables recording (check-out) to MiniDisc media.
- ❑ **MagicGate™ Memory Stick® media\*** — You can play back songs from the media, using the Memory Stick slot on your computer. The M drive enables recording (check-out) to MagicGate Memory Stick media.

---

\* SonicStage Premium software does not support standard Memory Stick media (blue color).

## **Devices**

- ❑ **FM Tuner** — Your VAIO® MX computer features a built-in FM tuner, enabling you to listen to and record from local FM radio stations. Your recorded material is converted into OpenMG™ format or WAV format.
- ❑ **Devices that are compliant with OpenMG technology standards** — The USB ports on your computer enable you to connect a compatible device that can play and record your audio files.
- ❑ **Devices that are connected to the computer's external input ports or jacks** — You can listen to and record from a connected device.

## **Audio file formats**

- ❑ OpenMG format: ATRAC3 files with the file extension .omg.
- ❑ WAV format
- ❑ MP3 format
- ❑ Audio files that are compliant with WMT (Windows Media™ Technology).

 Some MP3, WAV, and WMT compliant files may have incompatible sampling rates and cannot be imported. For details on importing files, see the SonicStage Premium Help file.

## **Electronic Music Distribution (EMD) Services**

EMD enables you to download music files via the Internet. To use Internet services that are compatible with SonicStage, you need:

- ❑ Access to the Internet from your computer. Sign up with an Internet Service Provider (ISP) and configure your computer for Internet access before using EMD services.
- ❑ An EMD service provider. Consult the provider for information about service.

## **Using SonicStage Premium Software**

When you start SonicStage Premium software for the first time, certain settings must be enabled in order to use the software to listen to FM radio stations and to play audio files.

 Connect the FM Tuner before attempting to scan the frequencies of available FM radio stations in the SonicStage Premium software application.

### **To start SonicStage Premium software (First time)**

- 1 Click **Start** in the Windows taskbar, and click **All Programs**.
- 2 Point to **SonicStage Premium**, and click **SonicStage Premium**.
- 3 At the first use of SonicStage Premium software, a dialog box appears and prompts you to register with the Compact Disc Database (CDDDB) music service. From this dialog box, you can choose to:
  - Click **Cancel** to end the CDDDB registration process for the current session. The CDDDB registration dialog box displays the next time you start SonicStage Premium software.
  - Create a new CDDDB account. If you are connected to the Internet before launching SonicStage Premium software, follow these steps:
    - 1 Select **This is a new CDDDB Registration**. Click **Next**.
    - 2 Follow the on-screen instructions to complete the registration process.
  - Access your existing CDDDB account. If you are connected to the Internet before launching SonicStage Premium software, follow these steps:
    - 1 Select **I already have a CDDDB Nickname**. Click **Next**.
    - 2 Follow the on-screen instructions to log on and access your existing account.

The SonicStage Premium main window appears, enabling you to continue your launch of the SonicStage Premium software.

- 1 In the software's main window, a dialog box appears. You are prompted to start scanning FM radio station frequencies. Click **Yes**.

Your computer starts scanning and displays a progress window.
- 2 A dialog box appears with the message, "Confirm the setup of SonicStage Premium." From this dialog box, you can choose to:
  - Set up SonicStage Premium software to automatically launch when you double-click audio files.
  - Select the type of audio files that can be played back with SonicStage Premium software.



- ❑ Confirm playback settings each time SonicStage Premium software is launched.

*SonicStage Premium main window*

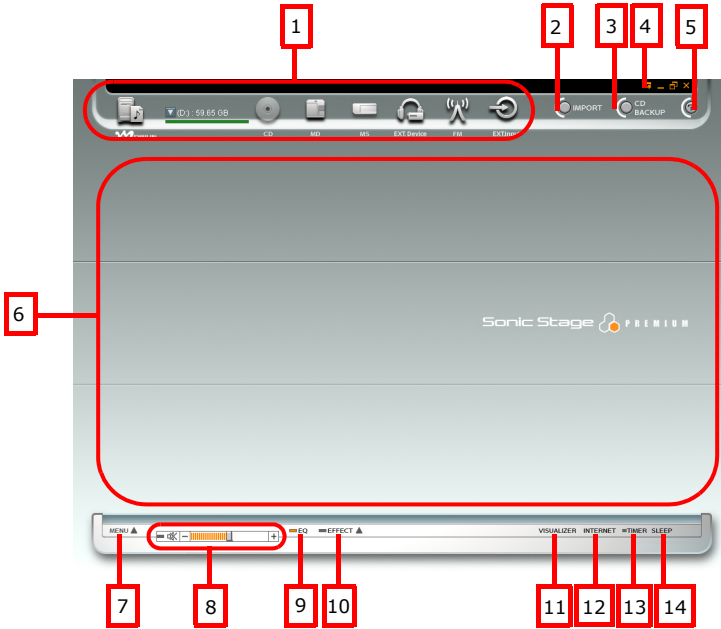

- **1 Audio source icons**  
Identifies the audio sources.

---
- 2 IMPORT button**  
Displays the **Import** window.

---
- 3 CD BACKUP button**  
Displays the **Create Audio CDs** window.

---
- 4 Simple Mode Switch button**  
Switches the main window view to the simple mode view.

---
- 5 Help button**  
Displays the SonicStage Premium Help file.

---
- 6 Operation area**  
Displays the operation panels for the audio sources.

---
- 7 MENU button**  
Displays the main menu.

---
- 8 Volume Control button**  
Increase or decrease sound volume when playing back songs from audio sources.

---
- 9 Equalizer button**  
Displays the **MX Equalizer** dialog box, enabling you to change the equalizer options.

---
- 10 Sound Effect button**  
Enables or disables the current sound effect selection.

---
- 11 Visualizer button**  
Minimizes or maximizes the **Visualizer** window. The **Visualizer** window offers various images that respond to music playback.

---

---

**12 Internet button**

Minimizes or maximizes the Internet connection window. The Internet window enables you to download or listen to audio files from EMD services.

---

**13 Timer Set button**

Minimizes or maximizes the **Timer Setting** window. The **Timer Setting** window enables you to set up timed playback or recording events.

---

**14 Sleep Timer button**

Your computer can be set up to automatically enter Stand by mode using the **Sleep Timer** button.

---

***Using the audio source icons***









The audio source icons initiate the functions of SonicStage Premium software for the related audio media or device. You can play back or record music using a drag-and-drop or double-clicking operation.

- Click on an audio source icon to view a **Playback** panel.
- Double-click on an audio source icon to begin music playback.
- Right-click on an audio source icon to view a shortcut menu of available functions.
- Drag one audio source icon onto another to perform recording or check-in/check-out functions.

---

Change text in this variable definition to document title.

---

<i>Icon</i>	<i>Description</i>
	Audio source is the  (music database) on your hard disk drive. The <b>Playlist</b> icon also identifies audio files that are registered to a specific playlist in the M drive.
	Audio source is a CD, CD-R, or CD-RW inserted into your computer's optical drive.
	Audio source is a MiniDisc inserted into your computer's MiniDisc drive.
	Audio source is MagicGate™ Memory Stick® media inserted into your computer's Memory Stick slot. (Note: Standard Memory Stick media (blue color) is not compatible with SonicStage Premium software.)
	Audio source is an external device or media connected to the USB port on your computer.
	Audio source is your computer's built-in FM tuner.
	Audio source is for recording purposes. This icon identifies a device connected to the external input port or jack on your computer, such as the LINE IN, OPT IN, or MIC.

---

### **Using the basic operations**

The functions and operation of each audio source is controlled through three windows:

- ❑ **Playback Panel** — This window enables you to play songs from the selected audio source. You can control the music by using functions such as repeat, shuffle, fast forward, and rewind. The available functions on the **Playback** panel may vary, depending on the selected audio source icon.

- ❑ **Contents Panel** — This window displays a list of songs from the audio source or from a Playlist. You can also view information about the song, such as the artist name, song title, or duration of playback.
- ❑ **Edit Panel** — This window enables editing of the songs from the audio source. You can rearrange song order or add or delete songs from the audio source or Playlist.



 If you select the FM tuner or external device icons, a **Listening** panel is displayed. The functions of the **Listening** panel differ from the **Playback** panel. See the SonicStage Premium Help file for more information.



## Using Playback and Recording Features

### Playing an audio CD



When you play an audio CD in your computer's optical drive for the first time, you are prompted to select playback options and to check the operation of the drive. Follow the instructions in the dialog boxes, and set up SonicStage Premium software to automatically play your audio CDs and to verify the optical drive operation.

- 1 Insert the audio CD into the optical drive. The **CD Playback** panel appears.

 If the **Playback** panel does not automatically display, click the  icon. You can double-click the icon to automatically start playback of the audio CD.

- 2 Click  (Play) on the **Playback** panel to begin playback from the beginning of the audio CD.
- 3 Click  (Show List) on the **Playback** panel to view the **Contents** panel. A song list of the music on the audio CD is displayed.
- 4 Select the song you wish to play. Click **Play** on the **Playback** panel to begin the selected song.

 You can double-click on a specific song to automatically begin playback.

- 5 Click  (Stop) on the **Playback** panel to stop playback.
- 6 Click  (Play) during playback to pause the song. Click on the icon again to resume playback.

---

Change text in this variable definition to document title.

- 7 Click  (Eject) on the **Playback** panel to eject the audio CD from the drive.

 The Timer Playback and Sleep Timer functions are disabled during song playback.





**Do not open or close the optical drive during playback.**

### ***Recording an audio CD***

You can record songs from an audio CD and register them to a Playlist on your hard disk drive.

#### ***To record all songs on an audio CD***

- 1 Insert the audio CD into the optical drive. The **CD Playback** panel appears.
- 2 Drag the  (CD) icon onto the  (M drive) icon. The **Record** window appears.
- 3 Click **Show List** on the **Record** window. The songs on the audio CD are listed in the **List** panel. You can click  (CD Info) to view information about the songs on your CD if you are connected to the Internet.
- 4 Select the format and bit rate for your recording session. Click **Record All** to begin recording all the songs on the CD.

#### ***To record specific songs on an audio CD***

- 1 Follow steps 1-3 as described in the previous section.
- 2 From the **List** panel, use a check mark to select the songs you want to record. Clear the check marks from those songs you do not wish to record.
- 3 Select the format and bit rate for your recording session. Click  (record) to begin recording the selected songs.

#### ***To play songs on your hard disk drive (Playlist)***

- 1 Click the  (M drive) icon. The **Playlist Playback** panel appears.
- 2 Click **Show List** on the **Playback** panel to view the **Contents** panel. The Playlists on your hard disk drive are displayed.



You can find a specific Playlist using the categories function. Search for the

desired Playlist by artist name, genre, or keywords.

- 3 Double-click to select a Playlist.
- 4 Double-click on a song to begin playback.

### ***To play a MiniDisc***

- 1 Insert the MiniDisc into the MiniDisc drive. The **MiniDisc Playback** panel appears.

 If the **Playback** panel does not automatically display, click the  (MiniDisc audio source) icon. You can double-click the icon to automatically start playback of the MiniDisc.

- 2 Click **Play** on the **Playback** panel to begin playback from the beginning of the MiniDisc.
- 3 Click **Show List** on the **Playback** panel to view the **Contents** panel. A song list of the music on the MiniDisc is displayed.
- 4 Select the song you wish to play. Click **Play** on the **Playback** panel to begin the selected song.
- 5 Click **Stop** on the **Playback** panel to stop playback.
- 6 Click **Play** during playback to pause the song. Click on the icon again to resume playback.
- 7 Click **Eject** on the **Playback** panel to eject the MiniDisc from the drive.







**Do not eject the MiniDisc media during playback.**

### ***Recording songs to a MiniDisc (Check-out)***

When you record songs from an audio CD to a MiniDisc, the songs are recorded into a Playlist on your hard disk drive and then checked out to the MiniDisc.

 Before recording to a MiniDisc, verify that the media is not write-protected.

### ***To record songs to a MiniDisc***

- 1 Insert the audio CD into the optical drive.
- 2 Insert the MiniDisc media into the MiniDisc drive.
- 3 Drag the  (CD) onto the  (MiniDisc) icon. The **Record** window appears.
- 4 Click **Show List** on the **Record** window. The songs on the audio CD are listed in the **List** panel. You can click the **CD Info** button to view information about the songs on your CD if you are connected to the Internet.
- 5 Select the format and bit rate for your recording session.
- 6 Click . The **MD Recording Mode** dialog box appears. Choose the appropriate recording mode, depending on format and bit rate selected previously. For details on setting the format and bit rate, see the SonicStage Premium Help file.
  - LP2 Stereo Recording mode
  - LP4 Stereo Recording mode
  - Stereo Recording mode
  - Mono Recording mode
- 7 Select the recording (check-out) mode. Click **OK**.
- 8 Click  (Stop Record) to stop or cancel the recording session.



 For more information on recording to a MiniDisc (Check-out), see the SonicStage Premium Help file.

### ***To play songs from MagicGate Memory Stick media***

- 1 Click the  (MagicGate™ Memory Stick® media) audio source icon. The Memory Stick media **Playback** panel appears.

The **Check-in/Check-out** window appears if the Memory Stick media is inserted while SonicStage Premium software is running. You can play songs by using the **Playback** panel on the right side of this window.









 If the **Playback** panel does not automatically display, click the  icon with the Memory Stick media inserted into the Memory Stick slot of your computer. You can double-click the icon to automatically start playback of the Memory Stick media.

- 2 Click **Show List** on the **Playback** panel to view the **Contents** panel. A song list of the music on the Memory Stick media is displayed.
- 3 Select the song you wish to play.
- 4 Click **Play** on the **Playback** panel to start the selected song.

### ***Recording songs to Memory Stick media or to a portable audio device (Check-out)***

You can record songs from an audio CD to MagicGate™ Memory Stick® media or to an external device that is compliant with OpenMG™ software standards. The songs are recorded to the M drive on your hard disk drive, and then checked out to the Memory Stick media or portable audio device.

 Before recording to Memory Stick media, verify that the media is not write-protected.

- 1 Insert the audio CD into the optical drive.
- 2 Insert the Memory Stick media into the Memory Stick media slot, or connect the external device to the computer.
- 3 Drag the  (CD) icon onto the  (Memory Stick media) icon or the  (external device or media) icon. The **Record** window appears.
- 4 Click **Show List** on the **Record** window. The songs on the audio CD are listed in the **List** panel. You can click **CD Info** to view information about the songs on your CD if you are connected to the Internet.
- 5 Select the format and bit rate for your recording session. For details on setting the format and bit rate, see the SonicStage Premium Help file.
- 6 Click  (Record). The recording session starts.
- 7 Click  (Stop Record) to stop or cancel the recording session.

### ***Playing songs from a portable audio device***

SonicStage™ Premium software is preinstalled in your computer and is designed to be immediately compatible with most portable audio devices. If your portable audio devices use OpenMG™ software, you must set up and configure each device before using it with SonicStage Premium software. Follow these steps to install your OpenMG software and configure a device:

- 1 Insert the OpenMG software CD supplied with your audio device.
- 2 When you are prompted to select installation options, select the option to install drivers only.
- 3 Select the driver option that corresponds with the model name and number of your audio device. Click **Install**.
- 4 Follow the onscreen instructions to complete the driver installation.
- 5 Restart your computer when prompted.
- 6 Connect your audio device to a USB port on your computer and wait for the Windows® operating system to detect it. (A message may appear in the Windows task tray.)

Open SonicStage Premium software:

- 1 Click **Start** in the Windows taskbar, and click **All Programs**.
- 2 Point to **SonicStage Premium**, and click **SonicStage Premium**. The SonicStage Premium main window appears.



Your audio device is configured for use with SonicStage Premium software.

 Earlier versions of OpenMG™ Jukebox software (version 2.1 or earlier) are not compatible with SonicStage Premium software. If you have difficulty installing your portable audio device, go to the manufacturer's support Web site to locate and download the latest drivers.

### ***To play songs from an portable audio (external) device or media***

- 1 Click the  (External device or media) icon. The **External Device Playback** panel appears.

The **Check-in/Check-out** window appears if the external device or media is connected or inserted while SonicStage Premium is running. You can play songs by using the **Playback** panel on the right side of this window.

 If the **Playback** panel does not automatically display, click the  icon with the external device/media connected or inserted into your computer. You can double-click the icon to automatically start playback of the songs on the device or media.

- 2 Click **Show List** on the **Playback** panel to view the **Contents** panel. A song list of the music on the external device or media is displayed.
- 3 Select the song you wish to play. Click **Play** on the **Playback** panel to start the selected song.

 You may not be able to play back songs on the audio device or media that were checked out from a different computer.

## **Using the Visualizer, Equalizer, and Sound Effects**

Your VAIO® MX computer has special features to enhance your music experience. You can view synchronized images while listening to music, enhance the sound quality and add special effects to your favorite songs.

### **To use the Visualizer**

- 1 Click **VISUALIZER**. The **Visualizer** window appears.
- 2 Click **Options**, and point to **Select Visualizer**. The images on the **Visualizer** window change, enabling you to select your preference.
- 3 Click **Full Screen** or double-click anywhere on the **Visualizer** window to view the images in full-screen mode. You can restore the original window size by pressing the Esc key or double-clicking anywhere on the **Visualizer** window.
- 4 Click **Visualizer** again to close the **Visualizer** window.

 The movements of Visualizer images do not synchronize with songs that are on a MiniDisc.

### **To use the MX Equalizer**

- 1 Click . The **MX Equalizer** window appears. Select the desired sound mode from the drop-down list.

---

<b>Sound Mode</b>	<b>Description</b>
<b>Flat</b>	Equalizes the gain in each frequency range. Use this mode if you do not want to apply equalization during playback.
<b>Pop</b>	Selects the settings that are most suitable for Pop music.
<b>Rock</b>	Selects the settings that are most suitable for Rock music.
<b>Jazz</b>	Selects the settings that are most suitable for Jazz music.
<b>Classic</b>	Selects the settings that are most suitable for Classical music.
<b>User1/User2</b>	Selects your customized equalizer settings. See “To use custom equalizer settings”.

---

- 2 Click **Close**. The next time you play a song, the selected sound mode is applied to the song.

### **To use custom equalizer settings**

- 1 Click . The **MX Equalizer Editor** dialog box appears.
- 2 Select **User1** or **User2**, and click **Edit**.
- 3 Use the sliders to adjust to Center frequency, Q-value, and gain.
- 4 Set the Bass Boost, as desired, by selecting the **On** option of the Bass boost. Move the slider to adjust levels.
- 5 Set the Treble, as desired, by selecting the **On** option of the Treble. Move the slider to adjust levels.
- 6 Click **OK**. The **MX Equalizer Editor** dialog box closes, and the settings are registered for **User1** or **User2**, depending on your selection.
- 7 Click **OK**. The **MX Equalizer** window closes.

**To use sound effect settings**

- 1 Click . A sound effects menu appears.
- 2 Select the desired sound effect from the menu.

 You may hear distortion during playback of some songs when sound effects have been added. If this occurs, select **Sound Effect Off** to turn off the sound effect.

<b>Effect</b>	<b>Description</b>
<b>Vocal Canceller</b>	Reduce or cancel the vocals in a song. You can also change the pitch of a song.
<b>Reverb</b>	Add reverberation to the sound, emulating different sound fields.
<b>Settings</b>	Make fine adjustments to each sound effect. See the SonicStage Premium Help file for more information on adjusting sound effects.

- 3 Click **Close**. The next time you play a song, the selected sound effect is applied to the song.

 You cannot apply sound effects to songs on a MiniDisc, audio from an FM radio station, or music from an external output.

**Using the FM Tuner**

Your VAIO® MX computer is equipped with a built-in FM tuner, enabling you to listen to and record from FM radio stations. Your FM antenna wire or FM coaxial antenna (supplied) must be connected to your computer before you can listen to FM radio stations.

**To listen to FM radio stations**

The first time that you use your FM tuner, you are prompted to start automatic frequency scanning.

- 1 At the first use of SonicStage Premium software, a dialog box appears and prompts you to start scanning frequencies of FM radio stations. Click **Yes**.



Your computer starts scanning and displays a progress window. After scanning is complete, the frequencies of available FM radio stations are sorted in ascending order and assigned a sequential number on the **Preset** panel.

 Subsequent scanning overwrites the FM radio stations listed on the **Preset** panel. If you wish to keep the current list of FM radio stations, select **No** when the scanning dialog box appears.

- 2 Click . The **FM Listening** panel displays. The computer tunes in to the preset FM radio station that is currently selected.

- 3 You can use preset or manual tuning to change FM radio stations:

- To use preset tuning, click  (FM Menu), and select **Tuning Mode - Preset** from the menu.
- To use manual tuning, click **FM Menu** and select **Tuning Mode - Manual** from the menu.

Click  or  on the **FM Listening** panel to locate a specific station or frequency.

For more information on selecting FM radio stations, see the SonicStage Premium Help file.

### ***To record from an FM radio station***

You can record from an FM radio station and register the audio file to a Playlist on your hard drive.

- 1 Click . The **FM Listening** panel appears.
- 2 Select the desired FM radio station.
- 3 Set up your audio input and recording settings by clicking **REC Setting**. Your audio input and recording options are:
  - Noise Reduction:** Enable or disable noise reduction during recording.
  - Time Machine Recording:** Set up a timer recording session.
  - Recording Format:** Specify the desired recording file format.

- ❑ **Edit FM Playlist:** Set up a Playlist to hold your recording session as a song.

 The maximum recording time is 150 minutes, regardless of format or bit rate settings. File size may vary, depending on audio input, recording format, or bit rate.

- 4 Move the **Level Adjust** slider to adjust the audio input level, if necessary.
- 5 Click  on the **FM Listening** panel to begin recording.
- 6 Click **STOP** on the **FM Listening** panel to stop recording. The recording session is registered to a Playlist as a song.

 You cannot change FM radio stations during a recording session.

### ***To use Quick Timer Recording***

To quickly set the amount time remaining to record:

- 1 Click  on the **FM Listening** panel during the recording session, to automatically set the recording time to 10 minutes.
- 2 Continue clicking on the icon to extend the recording duration by 10 minute increments.

### ***Using the Timer Functions***

You can use the timer functions to schedule one-time, daily, and weekly playback or recording events. SonicStage Premium software enables you to select the date, start time, end time, and timer event duration for the available audio sources.

 Timer events can only be performed when your computer's power is on, such as during active use, Stand by, or hibernation modes.

You cannot set up timer events for external devices or media.

### ***To set up a timer event***

You can set up a timer event by dragging an audio source icon directly onto the **Calendar**.

- 1 Click  (Timer). The **Timer Setting** window appears.
- 2 Use the directional icons to locate the start date for your timer event.

- 3 Drag the desired audio source icon to the **Calendar**, and drop it on the date you want the timer event to begin. A confirmation message appears.
- 4 Click **OK**.

 If you use the M drive audio source icon, the **Select Playlist** dialog box displays. Select the Playlist for the timer event, and click **OK**.

A **Timer Bar** (a thick, vertical line) appears in the **Calendar**, marking the duration of the timer event, and the event is added to the **Event List** on the **Timer Setting** window.

- 5 Adjust the start, end, and duration of the timer event by dragging either side of the **Timer Bar** to the desired location.

To move the **Timer Bar** to a new location, click on the center of the bar and drag it to a new time period.

The timer event setup is completed. At the scheduled time, SonicStage Premium software automatically starts the event from the selected audio source.

### ***To set up daily or weekly timer events***

- 1 From the **Timer Setting** window, click **New**. The **Timer Programming Settings** window appears.
- 2 Set the date, time, audio source, and repetition of the timer event. Click **OK**.

The daily or weekly timer event setup is completed. At every scheduled time, SonicStage Premium software automatically starts the event from the selected audio source.

 You can display the **Timer Programming Setting** window by double-clicking anywhere on the **Calendar** that does not have a **Timer Bar** displayed.

### ***To set the Sleep Timer***

The Sleep Timer function places your computer into Stand by mode after a predetermined period of time.

- 1 Click **SLEEP** (Sleep). The default Sleep Timer duration is 90 minutes. When the timer countdown is completed, the computer goes into Stand by mode.
- 2 Click **Sleep** to decrease the countdown duration by 10-minute increments.



### ***Additional information about Timer events***

If you perform any of the following operations when a timer event is set to begin, the scheduled event does not occur:

- Playing back songs or listening to audio from any audio source.
- Recording songs from an audio CD to a Playlist.
- Creating a backup audio CD.
- Writing songs from a Playlist to a CD-R media.
- Performing a check-in or check-out of songs.
- Importing audio files.
- Leaving the computer turned off.

When you attempt to change a timer event, the following aspects cannot be altered:

- The date, time, and duration of a completed or incomplete timer event.
- The date, time, and duration of a timer event in progress or about to start within three minutes. You can change the ending time if it is at least five minutes before the scheduled end time.
- The day of the week that a weekly timer event is scheduled to start. Use the Timer Programming Settings dialog box to change this information.

For more information about Timer functions, see the SonicStage Premium software Help file.

### ***Additional Information***

- SonicStage™ Premium Backup Tool** — You can back up and restore all of the music, graphics, and information data managed by SonicStage Premium software. You must be connected to the Internet to use the SonicStage Premium Backup Tool.
- Simple mode** — The main SonicStage Premium window in Simple mode is a smaller, compact version of the Full mode view. This can be useful when you want to listen to songs with SonicStage Premium software while using other software, or whenever you feel that Full mode view is intrusive. The Simple mode feature enables you to perform playback operations only.

---

*Change text in this variable definition to document title.*

# ADDITIONAL SOFTWARE INFORMATION

## **VAIO Edit Components Software**

VAIO Edit Components is a software plug-in for Adobe® Premiere® software that provides maximum compatibility and video quality for capturing video from your Sony digital camcorder. If your VAIO® computer did not have Adobe® Premiere® software preinstalled and you subsequently purchase and install Adobe® Premiere® software, install this software to ensure maximum compatibility with Sony digital camcorders.

### **To install VAIO Edit Components**

- 1 Insert your Application Recovery CD #1 into your optical drive.

 For some VAIO® models the VAIO Edit Components installer is on the #2 or #3 Application Recovery CD.

- 2 Click **Start**, click **My Computer**, and click your optical drive.
- 3 Click **Support**, and click **VEC**.
- 4 Double-click **Setup**.

The VAIO Edit Components installation wizard starts.

- 5 Follow the on-screen instructions in the installation wizard to complete the installation.
- 6 Restart your computer when prompted to do so.

---

*Change text in this variable definition to document title.*

# LEGAL INFORMATION

SONY ELECTRONICS INC. PROVIDES NO WARRANTY WITH REGARD TO THIS MANUAL, THE SOFTWARE, OR OTHER INFORMATION CONTAINED HEREIN AND HEREBY EXPRESSLY DISCLAIMS ANY IMPLIED WARRANTIES OF MERCHANTABILITY OR FITNESS FOR ANY PARTICULAR PURPOSE WITH REGARD TO THIS MANUAL, THE SOFTWARE, OR SUCH OTHER INFORMATION. IN NO EVENT SHALL SONY ELECTRONICS INC. BE LIABLE FOR ANY INCIDENTAL, CONSEQUENTIAL, OR SPECIAL DAMAGES, WHETHER BASED ON TORT, CONTRACT, OR OTHERWISE, ARISING OUT OF OR IN CONNECTION WITH THIS MANUAL, THE SOFTWARE, OR OTHER INFORMATION CONTAINED HEREIN OR THE USE THEREOF.

Sony Electronics Inc. reserves the right to make any modification to this manual or the information contained herein at any time without notice. The software described herein is governed by the terms of a separate user license agreement.

This product contains software owned by Sony and licensed by third parties. Use of such software is subject to the terms and conditions of license agreements enclosed with this product. Some of the software may not be transported or used outside the United States. Software specifications are subject to change without notice and may not necessarily be identical to current retail versions.

Updates and additions to software may require an additional charge. Subscriptions to online service providers may require a fee and credit card information.

Certain software product(s) included with this computer may include features such as copy protection and content management technology.

USE OF THE SOFTWARE PRODUCT(S) REQUIRES AGREEMENT TO APPLICABLE END USER AGREEMENTS AND FULL COMPLIANCE WITH APPLICABLE PRODUCT ACTIVATION PROCEDURES. Product activation procedures and privacy policies will be detailed during initial launch of the software product(s), or upon certain reinstallations of the software product(s) or reconfigurations of the computer, and may be completed by Internet or telephone (toll charges may apply).

---

*Change text in this variable definition to document title.*

© 2002 Sony Electronics Inc. Reproduction in whole or in part without written permission is prohibited. All rights reserved. Sony, VAIO, the VAIO logo, DVgate, Handycam, MovieShaker, i.LINK, ImageStation, Net MD, Network Walkman, OpenMG, ATRAC3, MagicGate, Memory Stick, MICROMV, OpenMG, SonicStage, Giga Pocket, and ATRAC3 are trademarks or service marks of Sony. Microsoft and Windows are trademarks or registered trademarks of the Microsoft Corporation.

All other trademarks are trademarks or registered trademarks of their respective owners.

# *Using the Recovery CDs*

*This section provides you with details on your Sony Application Recovery and System Recovery CDs.*

- ❑ Application and System Recovery CDs
- ❑ Using Your Recovery CDs

## **Application and System Recovery CDs**

Your computer comes with the following Application Recovery and System Recovery CDs. You will need an optical disc drive (supplied with selected models) to use these recovery CDs. If your computer does not come with an optical disc drive, use an external optical disc drive.

### **Application Recovery CD(s)**

*Sony Electronics Inc.*

This CD enables you to reinstall individual applications and device drivers if they become corrupted or are erased.

### **System Recovery CD(s)**

*Sony Electronics Inc.*

This CD enables you to restore the operating system and software that shipped with your computer if they become corrupted or are erased. This CD restores your computer to its original factory settings, so user data and applications installed since you started using your computer will be lost.

 For models that come with a docking station, make sure you connect the docking station to the computer before using the recovery CDs.



## **Using Your Recovery CDs**

The following sections describe how to use the Application Recovery and System Recovery utilities.

### **Using the Application Recovery CD(s)**

The Application Recovery CD utility enables you to reinstall individual software applications, device drivers, and to repair software applications if they become corrupted or are erased. Reinstalling an individual software application or device driver may correct a problem you are experiencing with your computer, peripheral hardware, or software. You may not need to reinstall the entire contents of your hard drive. To reinstall all the software titles that shipped with your computer, use the System Recovery CD(s). See “Using the System Recovery CD(s)” for more information.

 You must be in Windows® to run the Application Recovery CD utility.

#### **To reinstall software applications using the Application Recovery CD(s)**

- 1 Turn on your computer. If your computer is already on, close all open applications.
- 2 When the Windows desktop appears, insert Sony Application Recovery CD No. 1 into your computer’s optical disc drive. The Application Recovery utility loads automatically.
- 3 When the Application Recovery menu appears, select the icon for the application you want to restore, and then follow the on-screen instructions to complete the recovery process.

 Your system may include one or more Application Recovery CDs. If you have more than one Application Recovery CD, insert the first CD to run the Application Recovery program. You may be prompted to insert the next CD, depending on the application you wish to restore.

### **To reinstall device drivers using the Application Recovery CD(s)**

- 1 Turn on your computer. If your computer is already on, close all applications.
- 2 When the Windows desktop appears, insert Application Recovery CD No. 1 into the optical disc drive.
- 3 Click Start in the Windows taskbar, and click Control Panel. The Control Panel window appears.
- 4 Click Performance and Maintenance, and click System. The System Properties dialog box appears.
- 5 From the Hardware tab, click Device Manager.
- 6 Click to select the unknown device or the device that requires the driver installation. The unknown device(s) is identified by a yellow question mark.
- 7 From the Action menu, click Uninstall. This removes the device driver from your system. Click OK. Repeat for each device driver as necessary.
- 8 Restart your computer. Click Start in the Windows taskbar, select Turn Off Computer, and then click Restart.

When the desktop appears, Windows automatically reinstalls the device driver(s) from the Application Recovery CD.

 Your system includes one or more Application Recovery CDs. Insert Application Recovery CD No. 1, to start the application or driver recovery process. You are prompted to insert the next CD(s), depending on the software application or driver you wish to restore.

If you have any questions about using the Application Recovery CD(s), visit <http://www.sony.com/pcsupport>, or contact Sony Customer Support at 1-888-4-SONY-PC.

## **Using the System Recovery CD(s)**

The System Recovery CD(s) enables you to format your hard disk drive and restores all original software applications. Your computer is returned to the original factory settings.



**The System Recovery process removes all software that you may have installed since you started using your computer. Reinstall any applications that were not included with the computer when you purchased it.**

You can use the System Recovery CD(s) to reinstall the operating system and software titles that shipped with your computer if they become corrupted or are erased. You may not need to reinstall the entire contents of your hard drive. If you experience a problem with your computer, reinstalling an individual device driver or software title may correct the problem. Use the Application Recovery CD(s) to reinstall individual applications and to reinstall device drivers. See “Using the Application Recovery CD(s)” for more information.

The System Recovery CD(s) contains a backup copy of all the software originally installed on your hard disk drive. It can be used only to recover the hard disk of the computer you purchased.

### **System Recovery options**

- ❑ **System Drive Recovery** — All data on Drive C is deleted. The factory default settings and software applications are restored on this drive only.
- ❑ **Change Partition Size** — All partitions, custom installations, and changes are removed from the hard disk drive. You can set the partition sizes for both the Drive C and Drive D. The original, preinstalled operating system and software applications are restored.
- ❑ **Recovery to Original Factory Defaults** — All data and partitions are removed from the hard disk drive. All original factory settings, operating system, and preinstalled software is restored.



**The System Recovery utility does not back up your system's data. If you wish to retain your system data, perform a backup to an external media.**

### ***To use the System Recovery CD(s)***

Your system may take a few minutes to load necessary files. A blue screen appears during the downloading process.

- 1 Insert the Sony System Recovery CD in the optical disc drive. The System Recovery utility starts from the optical disc drive. The first CD must be in the drive when you turn on the computer.
- 2 Shut down your computer as described in the “Shutting Down Your Computer” section of your supplied Quick Start.
- 3 Wait 30 seconds and turn on your computer.
- 4 The VAIO System Recovery Utility dialog box appears. Click Next.
- 5 At the pop-up prompt, select Yes to begin the system recovery process. Follow the on-screen instructions.

### ***If your computer does not start from the Recovery CD***

- 1 Press the power button and hold it for more than four seconds to turn off the computer.
- 2 Turn on the computer. When the Sony logo is displayed, press the F2 key. The BIOS setup menu screen appears.
- 3 Press the arrow keys to select the Exit menu.
- 4 Press the arrow keys to select “Get Default Values” and then press the Enter key. The message “Load default values for all SETUP items.” appears.
- 5 Make sure “Yes” is selected, and press the Enter key.
- 6 Press the arrow keys to select “Save and Exit,” and press the Enter key. The message “Save configuration changes and exit now?” appears.
- 7 Make sure “Yes” is selected, and press the Enter key. The computer restarts from the Recovery CD.

 Your system may include one or more System Recovery CDs. If you have more than one System Recovery CDs, insert the first CD to run the System Recovery program. You are prompted to insert the second CD once the information from the first CD has been installed.

The recovery process takes from 30 to 60 minutes to complete.

After recovering your system using the System Recovery CD(s), you may be prompted to insert your Application Recovery CD(s) after restarting Windows. Insert the Application Recovery CD to automatically complete recovery of your system.



# Troubleshooting

*This section describes how to solve common problems you may encounter when using your computer. Many problems have simple solutions, so try these suggestions before you contact Sony Computing Support (<http://www.sony.com/pcsupport>). Consult the following sections:*

- ❑ Troubleshooting Your Computer
- ❑ Troubleshooting the Docking Station
- ❑ Troubleshooting the LCD Screen
- ❑ Troubleshooting the Mouse and Touchpad
- ❑ Troubleshooting Drives, PC Cards, and Peripheral Devices
- ❑ Troubleshooting the Software
- ❑ Troubleshooting i.LINK Devices
- ❑ Troubleshooting the Modem
- ❑ Troubleshooting Audio
- ❑ Troubleshooting Wireless LAN functions
- ❑ Troubleshooting the Printer

## **Troubleshooting Your Computer**

### ***My computer does not start.***

- ❑ Check that the computer is plugged into a power source and that it is turned on. Check that the power indicator on the computer's front panel shows the power is on.
- ❑ Check that the battery packs are inserted properly and are charged.
- ❑ If you are connected to a docking station with a floppy disk drive or an external floppy disk drive, make sure the floppy disk drive is empty.
- ❑ Confirm that the power cord and all cables are connected firmly, as described in the section "Connecting a Power Source" of your printed Quick Start.
- ❑ If the computer is plugged into a power strip or UPS, make sure the power strip or UPS is turned on and working.
- ❑ If you are using an external display, check that it is plugged into a power source and turned on. Check that the brightness and contrast controls are adjusted correctly. See the manual that came with your display for details.
- ❑ Take the battery pack off the computer, unplug the power cord and plug it in again, then turn on the power.
- ❑ If the power control button does not function, remove the AC adapter and battery pack and wait one minute, then reattach them and press the power button.
- ❑ Condensation may cause the computer to malfunction. If this occurs, do not use the computer for at least one hour.

### ***My computer starts but a BIOS error appears.***

When the internal backup battery is low on power, your system may not start properly, and the message "Press <F1> to resume, <F2> to setup" may appear at the bottom of the screen. Follow these steps:

- 1 Press the F2 key. The BIOS Setup menu appears.
- 2 Set the date (month/day/year). Press the Enter key.
- 3 Press  to select System Time, then set the time (hour: minute: second). Press the Enter key.



- 4 Press → to select Exit, then press ↓ to select Get Default Values. The message “Load default values for all SETUP items” appears.
- 5 Press the Enter key. The Setup Confirmation window appears.
- 6 Select Yes, and press the Enter key.
- 7 Select Exit (Save Changes), then press the Enter key. The Setup Confirmation window appears.
- 8 Select Yes, then press the Enter key. The computer restarts.

 If this occurs on a regular basis, contact Sony Computing Support (<http://www.sony.com/pcsupport>).

***My computer starts, but the message “Operating system not found” appears, and Windows does not start.***

- ❑ If you have connected a docking station with a floppy disk drive or an external floppy disk drive, make sure there is no floppy disk in the floppy disk drive (non-bootable).
- ❑ If a non-bootable floppy disk is in the drive, proceed as follows:
  - 1 Shut down the computer, then remove the floppy disk.
  - 2 Restart the computer and confirm that the Windows operating system starts properly.
- ❑ If Windows still does not start, follow the steps below to initialize the BIOS:
  - 1 Remove any floppy disk from the floppy disk drive.
  - 2 Shut down the computer.
  - 3 Remove any peripheral devices connected to the computer.
  - 4 Turn on the computer.
  - 5 Press the F2 key when the Sony logo appears. The BIOS setup menu window appears.
  - 6 Press the directional arrow keys to select the Exit menu.
  - 7 Press the arrow keys to select Get Default Values, then press the Enter key. The message “Load default values for all SETUP items” appears.
  - 8 Press the Enter key, and select Yes.

- 9 Use the directional arrow keys to select Exit (Save Changes), then press the Enter key. The message “Save configuration changes and exit now?” appears.
- 10 Select Yes, then press Enter. The computer restarts.

If your computer continues to display the message “Operating system not found,” and Windows does not start, use your supplied System Recovery CD to restore the software titles shipped with your computer. See “Using the System Recovery CD(s)” for more information.



**The System Recovery CD restores your computer to its original state, so user data and applications will be lost.**

### ***My computer stops responding or does not shut down.***

It is best to shut down your computer using the Shut Down command on the Windows Start menu. Using other methods, including those listed below, may result in loss of unsaved data.

- On the Windows taskbar, click Start, click Shut Down, then select Shut Down again, and click OK.
- If you cannot shut down your computer as described in the preceding step, press the Ctrl+Alt+Delete keys simultaneously and click Shut Down on the Windows Security window.
- If the preceding step does not work, press and hold the power button for at least four seconds to turn off the power.
- Unplug the computer from the AC adapter and remove the battery pack from your computer.
- If your computer stops responding while playing a CD or DVD, press the Ctrl+Alt+Delete keys simultaneously, and click Shut Down on the Windows Security window.



Pressing the Ctrl+Alt+Delete keys simultaneously or turning off the computer with the power switch may result in data loss in files that are currently open.

### ***My computer is unstable.***

Your computer's operating system may become unstable if a lower power state, such as Hibernate, is initiated then changed before the computer completely enters the lower power state.

To restore the computer to its normal operating stability:

- 1 Close all open applications.
- 2 Restart the computer by pressing the Ctrl+Alt+Delete keys simultaneously, and clicking Restart on the Windows Security window.
- 3 If this procedure does not work, press and hold the power button for four seconds or longer to shut down the computer.

### ***The sound of my computer's fan is too loud.***

Use the PowerPanel™ utility to change the Thermal Control Strategy setting to Quiet. This setting slows down the CPU speed. See PowerPanel Help for more information.

#### ***To reduce fan noise***

- 1 Right-click the Battery icon on the taskbar, and select Edit/Create Profiles. The AC Power Profile - Editor window appears.
- 2 Double-click System to open the file if it isn't already opened.
- 3 Double-click Thermal Control Strategy - Performance, and select Quiet.
- 4 Restart your computer.

### ***Why does the System Properties dialog box display a slower CPU speed than advertised?***

This is normal. Because your computer's CPU utilizes a type of CPU speed controlling technology, System Properties may display the CPU's current speed instead of the maximum advertised speed.

## **Troubleshooting the Docking Station**

### ***I cannot operate the optical drive in the docking station, when the docking station is connected to the computer.***

Follow these steps to set the i.LINK®\* network switch.

- 1 Disconnect your computer from the docking station.
- 2 Disconnect the AC adapter and all cables from your docking station.
- 3 Set the i.LINK® network switch on the bottom of the docking station to the unmarked side with a thin pen tip.
- 4 Connect the docking station to the computer.
- 5 Turn on your computer.



Do not set the i.LINK network switch when the computer is on. This causes the computer to malfunction.

Set the i.LINK network switch after removing all cables connected to the docking station.

### ***I cannot operate the optical drive in the docking station, when the docking station is connected to the computer and the computer is connected to another computer via an i.LINK connection.***

Set the i.LINK® network switch at the bottom of the docking station to the marked ● side. See “If your computer is connected to the docking station” for more information.

---

\* i.LINK is a trademark of Sony used only to designate that a product contains an IEEE 1394 connection. The i.LINK connection may vary, depending on the software applications, operating system and compatible i.LINK devices. All products with an i.LINK connection may not communicate with each other. Refer to the documentation that came with your compatible i.LINK device for information on operating conditions and proper connection. Before connecting compatible i.LINK PC peripherals to your system, such as a CD-RW or hard disk drive, confirm their operating system compatibility and required operating conditions.

***An error message appears while disconnecting the docking station, even after following the correct procedure for disconnecting the docking station.***

Close the software in use, disconnect other devices being used, then try to disconnect the docking station from the computer.

***I cannot remove the disc.***

You cannot remove the disc when the computer is in power saving mode. Return to normal mode, then press the Eject button.

***The disc tray does not eject even after I press the Eject button.***

Open the tray by inserting a thin, straight object (such as a paper clip) in the manual eject hole.

## **Troubleshooting the LCD Screen**

### ***My LCD screen is blank.***

- Verify the computer is plugged into a power source and is turned on.
- Verify the power indicator on the computer is on.
- Verify the battery pack(s) is inserted properly and is charged.
- The computer may be in LCD (Video) Standby mode. Press any key to activate the screen.
- The display mode may be set to external display mode. Press and hold the Fn key while pressing the F7 key several times.

### ***My LCD screen continues to show the previous screen.***

Press the Windows key and “D” key twice to refresh the screen.

### ***The image on my connected external display is not centered or sized properly.***

Use the controls on your external display to adjust the image. See the manual that came with your display for more information.

### ***I want to change the video resolution of my display.***

- 1 Click Start on the Windows® taskbar, then Settings, then Control Panel, and then the Display icon. The Display Properties dialog box appears.
- 2 Click the Settings tab.
- 3 Move the Screen area slider to change your video resolution.

## **Troubleshooting the Mouse and Touchpad**

### ***My mouse does not work.***

- ❑ If you are using an optional Sony PCGA-UMS1 series USB mouse, verify that the mouse is plugged into the USB port. See “Connecting a USB Device” for more information.
- ❑ If you are still experiencing problems, use your supplied Driver Recovery CD to reinstall the mouse drivers. See “Using the Application Recovery CD(s)” for more information.

### ***My touchpad does not work properly.***

- ❑ You may have disabled the touchpad without connecting a mouse to the computer. To enable the touchpad:
  - 1 Press the Windows key and use the arrow keys to select Programs. Press the Enter key.
  - 2 Use the arrow keys to select Sony Notebook Setup, and press the Enter key
  - 3 Select Sony Notebook Setup again, and press the Enter key.
  - 4 Use the arrow keys to select the Touchpad tab, and press the Tab key to select Enable Touchpad
  - 5 Press the Enter key.
- ❑ Restart the computer to activate the touchpad again.
- ❑ If your touchpad is interpreting a single tap as a double-click, adjust the button assignments. Follow these steps:
  - 1 Press the Windows key and use the arrow keys to select Settings. Press the Enter key.
  - 2 Use the arrow keys to select Control Panel, and then press the Enter key.
  - 3 Select Mouse, and then press the Enter key. The Mouse Properties dialog box appears.
  - 4 Make sure the Buttons tab is open, and change the button assignments in the Mouse Properties dialog box.

- ❑ If you are still experiencing problems, check that another mouse was not installed.
- ❑ You may need to use your Driver Recovery CD to reinstall the mouse drivers. See “Using the Application Recovery CD(s)” for more information.

***The pointer does not move when I use the Touchpad or Mouse.***

- ❑ Follow these steps to restart your computer:
  - 1 Press the Windows key.
  - 2 Press the “U” key. The Shut Down Window screen appears.
  - 3 Press the “R” key to restart the computer.
- ❑ If your computer does not restart, press the Ctrl+Alt+Delete keys simultaneously, and click Shut Down on the Windows Security window. Select Restart, and click OK.
- ❑ If your computer does not restart, press and hold the power button for more than four seconds to shut down the computer.
- ❑ If the pointer does not move while playing a disc, press the Ctrl+Alt+Delete keys simultaneously to stop playback and restart the computer.
- ❑ If you are still experiencing problems, check that another mouse was not installed.
- ❑ You may need to use your supplied Driver Recovery CD to reinstall the touchpad or mouse drivers. See “Using the Application Recovery CD(s)” for more information.



## **Troubleshooting Drives, PC Cards, and Peripheral Devices**

### ***My floppy disk drive cannot write to a floppy disk.***

- ❑ If the floppy disk is write-protected, disable the write-protect feature or use a floppy disk that is not write-protected.
- ❑ Verify the floppy disk is properly inserted into the floppy disk drive.

### ***My optical drive is not playing my CD or DVD properly.***

- ❑ Make sure the disc label is facing up.
- ❑ If the disc requires software, make sure the software is installed according to the manufacturer's instructions.
- ❑ A dirty or damaged disc may cause the computer to stop responding while it tries to read the disc. If necessary, restart the computer, remove the disc, and check the disc for dirt or damage.
- ❑ If you see video but cannot hear audio, check all of the following:
  - ❑ Check that your optical drive does not have the mute setting enabled.
  - ❑ Check the volume setting in the audio mixer.
  - ❑ If you are using external speakers, check the volume settings, and then check the connections between your external speakers and the computer.
  - ❑ Click Start on the Windows® taskbar, then Settings, then Control Panel, and then System. Select the Hardware tab, and click Device Manager. Check that the correct drivers are installed properly.
- ❑ Do not use adhesive labels to identify the CD. The label may come off while the disc is in use in the optical drive and cause the drive to malfunction.
- ❑ If a region code warning appears when you try to use your optical drive, it may be the DVD you are trying to play is incompatible with the optical drive. Verify the region code listed on the DVD package.
- ❑ Condensation may cause the computer to malfunction. If this occurs, do not use it for at least one hour.

***My optical drive tray does not open.***

- ❑ Make sure the computer is turned on.
- ❑ Press the Eject button on the optical drive.
- ❑ If the Eject button does not work, open the tray by inserting a thin, straight object (such as a paper clip) in the hole to the right of the Eject button.

***I cannot use Digital Video (DV) devices. The message “DV equipment seems to be disconnected or turned off” appears.***

- ❑ Verify that the DV device is turned on and the cables are properly connected.
- ❑ If you are using multiple i.LINK®\* devices, the combination of the connected devices may cause unstable operation. In this case, proceed as follows:
  - 1 Turn off your computer and all connected devices.
  - 2 Disconnect the devices that are not in use.
  - 3 Ensure that all other devices are properly connected.
  - 4 Restart your computer.

***My PC Card does not work.***

- ❑ Check that the PC Card is installed properly.
- ❑ Check that the PC Card is compatible with Microsoft® Windows®.
- ❑ Use the Sony Notebook Setup utility to disable devices you are not currently using.
- ❑ Check that any necessary drivers were installed properly. See “Using the Application Recovery CD(s)” for more information on installing the drivers.

## **Troubleshooting the Software**

### ***My software program stops responding or crashes.***

Contact the software publisher or designated provider for technical support. See “Software Support Information” for contact information.

### ***When I click an application icon, the message “You must insert the application CD into your optical drive” appears, and the software does not start.***

- ❑ Some titles require specific files that are located on the application CD. Insert the disc and try starting the program again.
- ❑ Make sure you place the CD in the tray with the label side facing up.

### ***The application cannot find a file while a PC Card is inserted.***

Some PC Cards when inserted in a computer that is connected to the docking station may change the drive letters of the disk drives in the docking station. If this occurs, an application you are using may not be able to find files.

To correct this condition perform one of the following steps:

- ❑ Remove the PC Card, and restart your computer. Do not insert the PC Card while using that application.
- ❑ Change the drive letters of the disk drives of the docking station or of the PC Card. Refer to the Windows® help files or the application manuals to change the drive letters.

### ***What software do I use for CD-R/CD-RW software functions?***

Sony recommends using the preinstalled SonicStage software’s Record function to create any CDs on your VAIO® computer, if the specific model you purchased is preconfigured with all necessary components for CD-R and CD-RW capability.

Downloading the optional RealJukebox CD-burning component to create any CDs on your computer may interfere with normal system operations.

## Troubleshooting i.LINK Devices

### ***I cannot establish a connection between two VAIO computers when using an i.LINK cable.***

- 1 Disconnect the i.LINK®\* cable from both computers and reconnect it.
- 2 Wait for the computers to respond. If neither computer responds after a few moments, restart both computers.

 The computers may not recognize an i.LINK connection after returning from a power saving mode (Standby or Hibernate). If that happens, restart both computers to establish a connection.

---

\* i.LINK is a trademark of Sony used only to designate that a product contains an IEEE 1394 connection. The i.LINK connection may vary, depending on the software applications, operating system, and compatible i.LINK devices. All products with an i.LINK connection may not communicate with each other. Refer to the documentation that came with your compatible i.LINK device for information on operating conditions and proper connection. Before connecting compatible i.LINK PC peripherals to your system, such as CD-RW or hard disk drive, confirm their operating system compatibility and required operating conditions.

## ***Troubleshooting the Modem***

### ***My modem does not work.***

- ❑ Check that the telephone line is plugged into the line jack. See “Connecting a Telephone Line” for more information.
- ❑ Check that the telephone line is working by plugging the line in an ordinary telephone and listening for a dial tone.
- ❑ Verify the telephone number the program is dialing is correct.
- ❑ Verify the software you are using is compatible with the computer’s modem. (All preinstalled Sony programs are compatible.)
- ❑ If you are still experiencing problems, use your the Driver Recovery CD to reinstall the modem drivers. See “Using the Application Recovery CD(s)” for more information.

### ***My modem connection is slow.***

Your computer is equipped with a V.90 compatible modem. Many factors may influence modem connection speed, including telephone line noise or compatibility with telephone equipment (such as fax machines or other modems). If you think your modem is not connecting properly to other PC-based modems, fax machines, or your Internet Service Provider (ISP), check the following:

- ❑ Ask your telephone company to verify that your telephone line is free from any line noise.
- ❑ If your problem is fax-related, check that there are no problems with the fax machine you are calling and that it is compatible with fax modems.
- ❑ If you are having a problem connecting with your ISP, check that the ISP is not experiencing technical problems.
- ❑ If you have a second telephone line available, try connecting the modem to that line.

## **Troubleshooting Audio**

### ***My speakers have no sound.***

- ❑ If the built-in speakers are turned off, press the Fn+F3 keys or use the center Jog Dial control to turn on the speakers.
- ❑ If the speaker volume is turned to the minimum, press the Fn+F4 keys, then press **↑** or **→** to increase the volume, or you can use the center Jog Dial™ control to control the volume.
- ❑ If nothing is displayed when you press the Fn+F3 or Fn+F4 keys, proceed as follows:
  - 1 Click Start, point to Settings, and then to Control Panel.
  - 2 Click Sounds and Multimedia. The Sounds and Multimedia Properties dialog box appears.
  - 3 Select the Audio tab, and click Advanced in the Sound Playback box. The Advanced Audio Properties dialog box appears.
  - 4 Make sure the Speakers tab is open, and the correct speaker setup is selected in the Speaker Setup box. Click OK.
  - 5 Click Volume in the Sound Playback box. The Volume Control dialog box appears.
  - 6 Make sure the mute check boxes are not selected in the Volume Control and Stereo Wide columns.
  - 7 Close the Volume Control dialog box.
  - 8 Click OK.
- ❑ If your computer is powered by batteries, verify the battery packs are inserted properly and are charged.
- ❑ If you are using an application that has its own volume control, verify the volume is turned up.
- ❑ Check the volume controls in the Windows® taskbar.
- ❑ If you connect external speakers:
  - ❑ Verify the speakers are properly connected and the volume is turned up.
  - ❑ If the speakers have a mute button, make sure the button is off.

- ❑ If the speakers are powered by batteries, verify the batteries are inserted properly and are charged.
- ❑ If you have connected an audio cable to the Headphone jack, disconnect the cable.
- ❑ If you are still experiencing problems, use the Driver Recovery CD to reinstall the drivers. See “Using the Application Recovery CD(s)” for more information.

***My microphone does not work.***

If you are using an external microphone, verify that the microphone is plugged into the Microphone jack. See “Connecting an External Microphone” for more information.

## ***Troubleshooting Wireless LAN functions***

### ***I cannot use the Wireless LAN functionality***

- ❑ Check if the Wireless LAN switch on the right side of the computer is in the ON position.
- ❑ If the Wireless LAN switch is in the ON position but you still cannot use the Wireless LAN functionality, do the following:
  - 1 Click Start and point to Programs.
  - 2 Select ORiNOCO, and click Client Manager. The ORiNOCO Client Manager window opens, displaying the connection status.
  - 3 Click File, and select “Enable Radio.”
  - 4 If you still cannot use the Wireless LAN functionality, restart the computer.

### ***I cannot set up a Wireless LAN.***

- ❑ When logging on to the computer, check if you have Administrator privileges. User with limited log-on privileges cannot modify certain computer settings.
- ❑ Check if the network connection is enabled. Do the following:
  - 1 Click Start, select Settings, and select Control Panel.
  - 2 Select System. The System Properties window opens.
  - 3 Click the Hardware tab, and then Device Manager. The Device Manager window opens.
  - 4 Double-click Network adapters, and then double-click ORiNOCO Mini PCI Card.
  - 5 Make sure the General tab is open and “Use this device (enabled)” is selected in the Device usage box.



### ***The computer cannot connect to a Wireless LAN Access Point.***

- ❑ Check if the Wireless LAN switch on the right side of the computer is in the ON position.
- ❑ Check if power to the Access Point is on.
- ❑ Check if the Access Point is displayed in the networks window. Do the following:
  - 1 Click Start, point to Settings, then Control Panel, and select Wireless Network. The Add/Edit Configuration Profile window opens.
  - 2 Click Edit.
  - 3 Type your profile name, and make sure Access Point is selected in the Network Type box. Click Next.
  - 4 Click Scan. The Scan for Network Names pop-up window opens.
  - 5 Look for the name of the network you are trying to connect with. If you see the name, select it and click OK. See “Connecting to a Wireless LAN” for more information.  
If you don’t see the name of the network, then try re-establishing the network connection. See “Connecting to a Wireless LAN” for more information.
- ❑ Connection availability is affected by distance and obstructions. You may need to move your computer away from obstructions or closer to any Access Point you may be using.
- ❑ Be sure that the encryption key is correct.

### ***I cannot access the Internet.***

- ❑ Check the Access Point settings. Refer to the instructions supplied with the Access Point.
- ❑ Check if your computer and the Access Point are connected to one another.
- ❑ Check the access point settings. Refer to the instructions supplied with the access point.
- ❑ Move your computer away from obstructions or closer to any access point you may be using.

***The data transfer speed is slow.***

- ❑ The Wireless LAN data transfer speed is affected by distance and obstructions between devices and access points. Other factors include device configurations, radio conditions, and software compatibility. To maximize the data transfer speed, move your computer away from obstructions or closer to any Access Point you may be using.
- ❑ If you are using a Wireless LAN Access Point, the device may be temporarily overloaded depending on the number of other devices communicating via the access point.

***The communication speed is interrupted or slowed down when MPEG2 data is transferred.***

The typical effective data transfer speed via an access point is 4-5 Mbps when adhering to the IEEE802.11b standard. High-rate stream transfers with MPEG2 data may lower this rate.

***The IBSS Ad-hoc mode channel is different from the one I specified.***

If the second computer in a “Peer-to-Peer Group” wireless connection specifies a different setting from the first computer, the settings from the first computer take priority.

***The settings cannot be saved in “Edit Configuration,” even when I enter the encryption key with “Use hexadecimal.”***

The setting “Use Alphanumeric Characters” may be checked on the display, but the settings with “Use hexadecimal” will be saved.

***The computer connects automatically to a Wireless LAN Access Point.***

If the Wireless LAN Access Point security setting is not specified at the factory, the access point may connect automatically upon installation. This is a factory specification and not a malfunction.

## ***Troubleshooting the Printer***

### ***I cannot print.***

- ❑ The default setting for the printer port mode is correct for most printers. If you cannot print, try changing the printer port mode.
  - 1 Click Start on the Windows® taskbar, and then click Settings.
  - 2 Click Control Panel, then Sony Notebook Setup, and select the Printer tab. If the printer port mode is set to ECP, change it to bi-directional. If the printer port mode is set to bi-directional, change it to ECP. See “Displaying the Sony Notebook Setup Screen” for more information.

Your connected printer may not function after the computer resumes from a power saving mode.

To reset the printer connection:

- 1 Click Start on the Windows® taskbar, select Settings, and select Control Panel.
- 2 Click the Printers folder.
- 3 Right-click on the icon of the printer that is not functioning, and select Properties to open the Properties window.
- 4 Click OK. The printer should now function properly.

Ensure that the printer is compatible with the Windows® operating system installed on your computer and that it has the correct printer drivers.



# Getting Help

*Sony provides you with several support resources to answer questions about your VAIO® computer or the preinstalled software. Refer to these resources in the order they are listed.*

## **Support Options**

If you have questions about your computer or the preinstalled software, refer to the following sources for answers in the sequence listed below.

- 
- 1 VAIO® Computer User Guide**  
The online VAIO® Computer User Guide and the printed VAIO® Computer Quick Start provide you with information on how to maximize your computer capabilities and solve common problems.

---

  - 2 Software Manuals and Online Help Files**  
The software preinstalled on your computer may come with an online manual. These manuals are stored on the hard disk drive as online Help files. You can find the Help files from the Help menu under the specific software application. Some software applications may come with a printed manual.

---

  - 3 Operating System Online Support**  
Your computer comes preinstalled with Microsoft® Windows®. For operating system support, you can access Microsoft® customer support at: <http://support.microsoft.com/directory/>.
-

**4 VAIO Support Agent**

You can find VAIO Support Agent by clicking Start and selecting Help and Support. Using advanced diagnostic technology, Sony's VAIO Support Agent runs scheduled protections of your applications, network settings, and other important software settings. When your software is protected, you can use VAIO Support Agent to repair software problems by restoring your software to any of the previously protected states.

---

**5 Sony Computing Support**

This service provides instant access to information on commonly encountered problems. Enter a description of your problem and the Knowledge Database searches for the corresponding solutions online. You can access Sony Computing Support at:  
<http://www.sony.com/pcsupport>.

---

**6 Sony Fax-on-Demand**

This service, which requires a fax machine or your fax software, provides answers to commonly asked questions. You can use this automated service to request a list of available topics, and select the topics that you want to receive. To contact the Sony fax-on-demand service, call: 1-888-4-SONY-PC (1-888-476-6972).

---

**7 Sony Customer Support**

Sony and Microsoft software support is available free of charge for 90 days after the original date of purchase. You can call and speak with a Sony Customer Support Representative without using your computer by calling: 1-888-4-SONY-PC (1-888-476-6972).

---

**8 Sony Service Center**

For the Sony Service Center nearest you, call 1-888-4-SONY-PC (1-888-476-6972) or find Sony Customer Service on the Web at <http://www.sony.com/pcsupport>.

---

# Index

## **A**

About This Computer tab 83  
AC Profile power setting 86  
Access Point, Wireless LAN 78  
adjusting  
    brightness 16  
Alt key 13  
Application Recovery CD 185  
Applications key 13  
audio

    troubleshooting 206  
Audio file formats 159  
audio file formats 155  
audio source icons 162, 163

## **B**

Basic/Advanced tab 83  
battery pack  
    charge status icons 89  
    indicator lights 14  
    power management settings 84  
    power saving modes 33  
brightness  
    adjusting 16  
built-in speaker 16  
    volume 16

## **C**

cameras  
    digital video recorder 70  
canceling commands 13  
Caps Lock  
    indicator light 15

CD-ROM discs  
    ejecting 55  
    inserting 54  
    removing 55  
    using 54  
CD-ROM drive  
    closing lid 55  
Check-In/Check-out 153  
choosing  
    display mode 92  
coin-operated telephones 35  
Compact Disc Database (CDDDB) 160  
computer  
    expanding capabilities of 78  
    indicators 14  
    setup screen 82  
    troubleshooting 192, 203  
connecting 54  
    coin-operated telephones 35  
    digital video camera recorder 70  
Ethernet 36  
external speakers 76  
floppy disk drive 52  
hard drives 25  
i.LINK device 70  
i.LINK optical disc drive 58  
microphone 77  
multiple telephone lines 35  
network 25, 44  
optical drive 54  
party telephone lines 35  
PBX 35

- port replicator 44
- printer 61
- telephone line 35
- USB device 68
- connectors
  - network 44
  - Serial port 44
- Contents Panel 165
- correction keys 12, 13
- Ctrl key 13
- cursor-movement keys 12

## **D**

- digital video camera recorder 70
- DigitalPrint software 119
  - LabelMaker 127
  - PhotoAlbum 125
  - PhotoCapture 119
  - PhotoCollection 122
  - PhotoDecor 124
- diskettes
  - troubleshooting 201
- disks
  - handling 53
- display
  - connecting external 63
  - mode 92
  - options 67
  - selecting 67
- docking station
  - troubleshooting 196
- drives
  - troubleshooting 201
- DV In/Out 70
- DVD drive
  - connecting 54
- DVD-ROM drive tray
  - troubleshooting 202
- DVgate software 129
  - AVI files 130

- using a digital video device 129

## **E**

- Edit Panel 165
- Eject button 52
- ejecting
  - CD-ROM discs 55
  - floppy disks 52
- Electronic Music Distribution 159
- Electronic Music Distribution service 149
- EMD service 149
- Equalizer 171
- Escape key 13
- expanding your computer capabilities 78
- expansion memory configuration 96
- external devices
  - display 63
  - speakers 76

## **F**

- floppy disk drive 52
  - troubleshooting 201
- floppy disks
  - connecting 52
  - ejecting 52
  - inserting 52
  - notes 53
  - using 52
- FM radio station scanning 160
- FM tuner 173
  - FM radio stations 173
  - recording from FM radio stations 174
- Fn key 13
  - combination commands 16
- Full mode 155
- function keys 13



**G**

getting help 213

Guide mode 23

**H**

handling

disks 53

hard drive

indicator light 14

headphone

connector 65, 66

help 213

Hibernate mode 17, 33, 88

**I**

i.LINK 70

connecting 70

i.LINK optical disc drive

connecting 58

notes on 60

IEEE 1394 70

ImageStation 136

indicator lights 14

battery 14

Caps Lock 15

hard drive 14

Num Lock 15

Scroll Lock 15

indicators 14

Insert key 12, 13

inserting

CD-ROM discs 54

floppy disks 52

**J**

Jog Dial Control 21

**K**

keyboard

Fn key 16

using 12

Windows key 15

**L**

Launcher mode 22

LCD

selecting to display output 67

troubleshooting 198

**M**

MagicGate 28

Maximum Battery Life power setting  
86

Maximum Performance power setting  
86

memory

adding 95

viewing the amount of 102

memory module

expansion 96

Memory Stick card slot 28

Memory Stick media 28

displaying contents 29

microphone

connecting 77

troubleshooting 207

modem

troubleshooting 205

modes

Guide 23

Hibernate 33

Launcher 22

Standby 33

monitor

connecting external display 63

selecting 67

switching among 16

mouse

troubleshooting 199

mouse properties 19

MovieShaker software 131

adding effects 133

- creating movies 132
- saving a movie 135
- uploading to Internet 137
- using ImageStation 136
- using the Shaker feature 132

multiple telephone lines 35

## **N**

navigation keys 12

network

- connecting 25
- connector 44
- port replicator 44

Notebook Setup tabs 83

Num Lock

- indicator light 15

## **O**

operator keys 13

optical drive 54

## **P**

party telephone lines 35

PBX 35

PC Card

- inserting 25
- troubleshooting 201
- using 25

PDA 78

peripheral devices

- troubleshooting 201

Personal Digital Assistant 78

Playback Panel 164

port replicator

- connecting 44
- network 44

power 14

power management

- settings 84

Power Management toolbar 84

Power On

Password tab 83

power saving modes 28, 33

- Hibernate 17, 33, 88
- normal 33
- Standby 17, 33, 88

power setting

- AC Profile 86
- Maximum Battery Life 86
- Maximum Performance 86
- Power Management Off 86

PowerPanel

- customizing toolbar 85, 88

Print Screen key 13

printer

- connecting 61
- troubleshooting 211

Printer tab 83

## **Q**

Quick Timer

- Recording 175

## **R**

Recovery CDs 185

removing

- CD-ROM discs 55
- floppy disks 52

restoring data 185

Reverb 173

## **S**

Scroll Lock

- indicator light 15

selecting

- display 67
- LCD 67
- monitor 67

Serial connector 44

setup screen

- About This Computer tab 83
- Basic/Advanced tab 83

- displaying 82
  - Power On Password tab 83
  - Printer tab 83
  - Touchpad tab 83
  - setup tabs 83
  - Shift key 13
  - Simple mode 155, 177
  - Skins 155
  - Sleep Timer 176
  - software
    - troubleshooting 203
  - SonicStage Premium
    - audio file formats 159
    - Audio source icons 162
    - Backup Tool utility 177
    - basic operations 164
    - compatibility 158
    - Devices 159
    - Equalizer 171
    - features 157
    - FM radio station scanning 160
    - Media 158
    - Overview 157
    - Playback and Recording 165
    - Setting up a timer event 175
    - Simple mode 177
    - Sleep Timer 176
    - Software 157
    - Sound Effects 171
    - Timer Functions 175
    - Visualizer 171
  - SonicStage software 149
    - Backup Tool 155
    - Electronic Music Distribution service 149
    - importing audio files 155
    - Main Features 149
    - managing imported songs 155
    - recording from a CD 151
    - Simple mode 155
    - transferring songs 153
    - Tutorial 155
  - Sony
    - online service 136
  - Sony Fax-on-Demand 214
  - Sony Notebook Setup screen 82
  - Sony Service Center 112
  - Sound effect settings 173
  - Sound Effects 171
  - speakers
    - external 76
    - troubleshooting 206
  - Standby mode 17, 33, 88
  - switching
    - display 16
    - monitor 16
  - System Recovery CD 187
- T**
- technical support 213
  - telephone
    - connecting line 35
    - jack 35
  - touchpad
    - troubleshooting 199
    - using 18
  - Touchpad tab 83
  - troubleshooting 192
    - audio 206
    - docking station 196
    - drives, PC Cards, and peripherals 201
    - LCD screen 198
    - modem 205
    - mouse and touchpad 199
    - printer 211
    - software 203

## **U**

### USB

- connecting 68
- connector 68
- mouse 68

### using

- floppy disk drive 52
- Jog Dial Control 21
- keyboard 12
- Memory Stick 28
- PC Card 25
- telephone line 35
- touchpad 18
- VAIO Action Setup 20

## **V**

### VAIO 20

### VAIO Action Setup 20

### VAIO Edit Components software 179

### video camera recorder 70

### viewing the amount of memory 102

### Visualizer 171

### Vocal Cancellor 173

## **W**

### window design of Sony software 92

### Windows

#### key 13

#### key combinations 15

### Wireless LAN 38

### Wireless LAN Access Point 78



